

Makita[®]

PROFESSIONALS AT WORK

PROMOTIEFOLDER

01/04/2016 - 30/09/2016

NIEUW
zie pg. 4 & 5

10.8V
LITHIUM-ION

NIEUW GAMMA
CXT 10.8V machines

DVC860LZ

HYBRID



Nat- en droogstofzuiger die werkt op netstroom en accu zie pg. 6

INHOUD

p. 14-32 Accumachines

p. 35-39 Hamers

p. 40-41 Boormachines

p. 43 Bevestigingen & Schroeven

p. 44 Metaal

p. 45-47 Slijpers

p. 48-49 Metaal & Beton

p. 50-59 Hout





























































p. 60 Stofzuigers

p. 61 Diversen

p. 62-64 Pneumatisch,

p. 65 Generatoren & Lasers

p. 66-79 Tuinbouwgereedschap

 Dubbel geïsoleerd	 Instelbaar koppel / aantal posities 16	 Lichtfunctie	 Single sequential firing
 Variabele snelheid	 Instelbaar koppel / aantal posities 18	 Snelspanboorkop met blokkeerpositie	 Velcro bevestiging
 Elektronische toerenregeling	 Instelbaar koppel / aantal posities 21	 Soft Start	 Laser
 Elektronische ontsteking	 Veiligheids- / slipkoppeling	 Easy Start	 Dial Depth Adjusting
 "Memory Power" Digitale ontsteking	 Stofafzuiging	 Easy Start	 Auto firing stop
 Scavenging Losses Rejection	 Decompressie klep	 Verstekzagen L45	 Kettingrem
 L+R schakelaar	 SDS-PLUS aansluiting	 Verstekzagen L45 R5	 Automatische kettingsmering
 2 mechanische snelheden	 SDS-MAX aansluiting	 Verstekzagen L+R	 Opvoerpomp
 3 mechanische snelheden	 SJS systeem	 Snelstart systeem	 Anti-vibratie systeem
 3 elektrische snelheden	 Zeskant opname 30 mm	 Inschakelautomaat	 360° werking
 2 elektrische snelheden	 Zeskant opname 28,6 mm	 Draaibare slagaansluiting	 Koffer
 Elektrische of mechanische rem	 Zaagbladopname enkelnokkenschacht	 Papieren filter	 Houten koffer
 Smart Impact Technology	 Pendelbeweging	 Inlet filter	 MAK PAC koffer
 Anti-vibratie systeem	 SJS II systeem	 Roestvrije tank	 MAK PAC koffer
 Extreme Protection Technology	 HEPA H13 filter	 Koolborstelloze gelijkstroommotor	 Deep and Exact Cutting Technology
		 Makita MM4 vieraktmotor	

MAKITA WERKT VOLGENS DE RICHTLIJNEN VAN DE EPTA



EPTA staat voor European Power Tool Association en is een vereniging van de belangrijkste fabrikanten van powertools. De EPTA stelt verplichte richtlijnen op, waardoor uniforme en vergelijkbare specificaties en gegevens gegarandeerd worden. Zo zijn er richtlijnen voor het gewicht (zonder snoer maar met alle machinetoebehoren die voor het normale gebruik noodzakelijk zijn), voor slagkracht, enz.

In het verleden had iedere fabrikant zijn eigen norm, daarom waren de gegevens voor de invoering van EPTA, van fabrikant tot fabrikant verschillend en niet met elkaar vergelijkbaar.

Om u zo correct mogelijk te informeren, meet Makita uitsluitend volgens de richtlijnen van de EPTA. In alle onze media (catalogi, folders, website, enz.) worden daarom enkel waarden conform de EPTA-richtlijnen gebruikt.

SLAGMOERSLEUTEL LXT 18V

DTW1001RTJ

NIEUW

**BL
MOTOR**



DTW1001RTJ



Drie-traps elektronische snelheidskeuze.

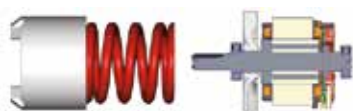

Onderhoudsvrije koolborstelloze motor met elektronische sturing levert meer koppel, behoudt de volle kracht bij linksom draaien en verzet meer werk met dezelfde accucapaciteit.



DTW1001RTJ

Batterijcapaciteit	18 V / 5,0 Ah
Gemiddelde oplaadtijd	45 min.
Toerental	0-1800 t.p.m.
Hard koppel / Bitopname	1050 Nm / 3/4" vierkant
Aantal accu's	2 x BL1850
Gewicht	3,4 kg
Prijs in €	Excl. BTW
	Incl. BTW

TELESCOPISCHE DUBBEL-VERSTEKZAAG OP ACCU LXT 2 X 18V

DLS714PT2

NIEUW



DLS714PT2

Batterijcapaciteit	18 V / 5,0 Ah
Gemiddelde oplaadtijd	45 min.
Toerental	5700 t.p.m.
Maximale zaagdiepte bij 90°	52 mm
Maximale zaagbreedte bij 90°	300 mm
Diameter zaagblad	190 mm
Gewicht	13 kg
Prijs in €	Excl. BTW
	Incl. BTW

Snellader DC10SA



Een 2.0Ah schuifbatterij volledig opgeladen in

30 minuten



DC10SA

Speciaal ontwikkeld voor het opladen van de nieuwe Li-ion 10.8V schuifbatterijen.

10.8V

LITHIUM-ION

AANGEDREVEN DOOR EEN LI-ION SCHUIFBATTERIJ VAN HET NIEUWE MAKITA GAMMA 10.8V MACHINES



Accu boor- en schroefmachine DF331D

Accu boor- en schroefmachine DF031D

Accu klopboor- en schroefmachine HP331D

Accu slagschroevendraaier TD110D



Accu reciprozaag JR103D



Accu Cirkelzaag HS301D



BL1020B
2.0Ah



BL1040B
4.0Ah



DF331DSAX1

		DF031DSAJ	DF031DSMJ
Batterijcapaciteit		10,8 V / 2,0 Ah	10,8 V / 4,0 Ah
Gemiddelde oplaadtijd		30 min.	60 min.
Hard koppel		30 Nm	30 Nm
Aantal accu's		2	2
Gewicht		0,9 kg	0,9 kg
Prijs in €	Excl. BTW		
	Incl. BTW		

		DF331DSAJ	DF331DSMJ	DF331DSAX1
Batterijcapaciteit		10,8 V / 2,0 Ah	10,8 V / 4,0 Ah	10,8 V / 2,0 Ah
Gemiddelde oplaadtijd		30 min.	60 min.	30 min.
Hard koppel		30 Nm	30 Nm	30 Nm
Aantal accu's		2	2	2
Gewicht		1,1 kg	1,1 kg	1,1 kg
Prijs in €	Excl. BTW			
	Incl. BTW			

		HP331DSAJ	HP331DSMJ
Batterijcapaciteit		10,8 V / 2,0 Ah	10,8 V / 4,0 Ah
Gemiddelde oplaadtijd		30 min.	60 min.
Hard koppel		30 Nm	30 Nm
Aantal accu's		2	2
Gewicht		1,1 kg	1,1 kg
Prijs in €	Excl. BTW		
	Incl. BTW		

		HS301DSAJ	HS301DSMJ
Batterijcapaciteit		10,8 V / 2,0 Ah	10,8 V / 4,0 Ah
Gemiddelde oplaadtijd		30 min.	60 min.
Maximale zaagdiepte bij 90°		25,5 mm	25,5 mm
Aantal accu's		2	2
Gewicht		1,6 kg	1,6 kg
Prijs in €	Excl. BTW		
	Incl. BTW		

		TD110DSAJ	TD110DSMJ
Batterijcapaciteit		10,8 V / 2,0 Ah	10,8 V / 4,0 Ah
Gemiddelde oplaadtijd		30 min.	60 min.
Hard koppel		110 Nm	110 Nm
Aantal accu's		2	2
Gewicht		1,0 kg	1,0 kg
Prijs in €	Excl. BTW		
	Incl. BTW		

		JR103DSAJ	JR103DSMJ
Batterijcapaciteit		10,8 V / 2,0 Ah	10,8 V / 4,0 Ah
Gemiddelde oplaadtijd		30 min.	60 min.
Max. zaagcapaciteit hout/stalen buis		50 mm	50 mm
Aantal accu's		2	2
Gewicht		1,1 kg	1,5 kg
Prijs in €	Excl. BTW		
	Incl. BTW		



HYBRID



Tweevoudige batterij indicatie. Variabele zuigkrachtregering laat een stillere werking toe en zorgt voor meer autonomie bij werkzaamheden die minder zuigkracht vergen.



Grote aan/uitschakelaar



		DVC860LZ
Batterijcapaciteit	Li-ion	
Nominale accuspanning	2 x 18 V	
Maximum debiet	2.1-3.6 m ³ /min	
Maximale onderdruk	90 - 240 mbar	
Gebruiksduur op hoge snelheid	30 min.	
Gewicht	9,2 kg	
Prijs in €	Excl. BTW	
	Incl. BTW	

PLATENFREES

CA5000XJ

NIEUW



Uitstekend toegankelijke revolver diepte-instelling met 3 naregelbare preselecties.

		CA5000JX
Vermogen		1300 Wat
Toerental onbelast max.		2200 - 6400 t.p.m.
Diameter zaagblad		118 mm
Gewicht		5,1 kg
Prijs in €	Excl. BTW	
	Incl. BTW	

ACCU HAAKSE SLIJPERS LXT 18V

DGA506RTJ / DGA508RTJ

NIEUW

Met heropstartbeveiliging en elektrische rem !



DGA506RTJ



DGA508RTJ

DGA508RTJ is uitgerust met een lepelschakelaar



		DGA506RTJ	DGA508RTJ
Batterijcapaciteit		18 V / 5,0 Ah	18 V / 5,0 Ah
Gemiddelde oplaadtijd		45 min.	45 min.
Ø schijf		125 mm	125 mm
Aantal accu's		2 x BL1850	2 x BL1850
Gewicht		2,5 kg	2,5 kg
Prijs in €	Excl. BTW		
	Incl. BTW		

18V LITHIUM-ION



DJV182
DJV181

DTW1001
DTW1002

DHS630 / DHS680
DSS501 / DSS610

DTM51

DKP180

DPJ180

DBO180

DGD800

DGA504
DGA505
DGA506
DGA508

DJN161

DJS130

DPB181

DJR183
DJR181

DCS551

DSC162
DSC191

DHR243
DHR202
DHR165

DTL061

DFR550
BFR750

DDA351
DDA350

DFS452

DTW281
DTW450

DTD129

DTD152
DTD148

DTS141
DTP141

DLS714

DHS710

DHR264

DUB362

DUH551 / DUH651

18V + 18V → 36V

DUR365U

DUR364L

DUC252

DLM380

DVC860L



3.0Ah BL1830 22min



45min 36min 24min 15min
5.0Ah BL1850 4.0Ah BL1840 2.0Ah BL1820 1.5Ah BL1815N



DBN500 DST221 DPT351

DUC122 DCG180

DVR850
DVR450
DVR350

DVC350

DUB182

DUH483
DUH523

DUM168

DUP361

DUR182L
DUR182U

DUR181

DCL500

DCL182

DCF050

STEXBML185

DMR050

DEADML802
DEABML803

STEXBML801

DMR102
DMR106B

DCF201
DCF300

DCJ200

DDF480
DDF482
DDF453

DDF459

DHP481

DHP480
DHP453



DCM500



WWW.MAKITA.BE



© MAKITA 2016

PROMO
Na online registratie
+ batterij BL1830
ter waarde van €

NIEUW



DHS630ZJ
€ Excl. BTW
€ Incl. BTW



DCS551ZJ
€ Excl. BTW
€ Incl. BTW



DJR181ZK
€ Excl. BTW
€ Incl. BTW



DTL061ZJ
€ Excl. BTW
€ Incl. BTW

NIEUW



DGA506ZJ
€ Excl. BTW
€ Incl. BTW

DGA508ZJ
€ Excl. BTW
€ Incl. BTW

NIEUW



DTW1001ZJ
€ Excl. BTW
€ Incl. BTW



DGD800ZJ
€ Excl. BTW
€ Incl. BTW



DPJ180ZJ
€ Excl. BTW
€ Incl. BTW



DPT351ZJ
€ Excl. BTW
€ Incl. BTW



DBN500ZJ
€ Excl. BTW
€ Incl. BTW



BJN161ZK
€ Excl. BTW
€ Incl. BTW



DTW450ZJ
€ Excl. BTW
€ Incl. BTW



DTM51ZJX2
€ Excl. BTW
€ Incl. BTW



DCL500Z
€ Excl. BTW
€ Incl. BTW



DCG180ZK
€ Excl. BTW
€ Incl. BTW



incl. kokerhouder (196352-6)
DCG180ZKXK
€ Excl. BTW
€ Incl. BTW



BJS130ZK
€ Excl. BTW
€ Incl. BTW

DVR350ZK € Excl. BTW / € Incl. BTW
DVR450ZK € Excl. BTW / € Incl. BTW
DVR850ZK € Excl. BTW / € Incl. BTW



KOOP NU EN ONTVANG EEN GRATIS BATTERIJ

Makita belooft zijn klanten: van 1 april 2016 tot en met 30 september 2016 ontvang je een gratis 18V 3,0Ah batterij (BL1830) als je in die periode één van bovenstaande 18V machines aanschaft. De actie geldt enkel voor bepaalde basis uitvoeringen zonder batterijen en snellader.

De actie is uitsluitend bedoeld voor de Belgische en Luxemburgse markt en enkel voor eindgebruikers die in België of Luxemburg wonen. De machine dient te zijn aangeschaft bij een officiële en geautoriseerde dealer van Makita België NV. Deze dealers kun je vinden in de dealerlocator op www.makita.be. Daar kan je ook de complete voorwaarden van deze actie raadplegen. Actie niet cumuleerbaar met andere acties en promoties en niet van toepassing op machines die deel uitmaken van een combokit of een omruiling in het kader van een reparatie.



LXT LITHIUM-ION



MAK PAC
DKP180ZJ
€ Excl. BTW
€ Incl. BTW



MAK PAC
DTW281ZJ
€ Excl. BTW
€ Incl. BTW



MAK PAC
DFR550ZJ
€ Excl. BTW
€ Incl. BTW



MAK PAC
DGA505ZJ
€ Excl. BTW
€ Incl. BTW



MAK PAC
DJV181ZJ
€ Excl. BTW
€ Incl. BTW



MAK PAC
DCO180ZJ
€ Excl. BTW
€ Incl. BTW



MAK PAC
DJV182ZJ
€ Excl. BTW
€ Incl. BTW



MAK PAC
DFS452ZJ
€ Excl. BTW
€ Incl. BTW



MAK PAC
DTP141ZJ
€ Excl. BTW
€ Incl. BTW



MAK PAC
DSS501ZJ
€ Excl. BTW
€ Incl. BTW



MAK PAC
DTD129ZJ
€ Excl. BTW
€ Incl. BTW



MAK PAC
DHS680ZJ
€ Excl. BTW
€ Incl. BTW



MAK PAC
DDA351ZJ
€ Excl. BTW
€ Incl. BTW



MAK PAC
DPB181Z
€ Excl. BTW
€ Incl. BTW



MAK PAC
DVC350Z
€ Excl. BTW
€ Incl. BTW



MAK PAC
DDA350ZJ
€ Excl. BTW
€ Incl. BTW



MAK PAC
DHR243ZJV
€ Excl. BTW
€ Incl. BTW



MAK PAC
DHR165ZJ
€ Excl. BTW
€ Incl. BTW



MAK PAC
DHR202ZJ
€ Excl. BTW
€ Incl. BTW



MAK PAC
DHR243ZJ
€ Excl. BTW
€ Incl. BTW



PAK JE VOORDEEL

Koop een basis 18V machine bij je Makita dealer. Na je aankoop maak je op www.makita.be een account aan (of gebruik je een bestaande account) en vul je op het formulier onder andere het serienummer (staat op de machine) en de EANcode (barcode) in. Upload daarnaast ook een kopie van je aankoopfactuur. Na ontvangst van de correcte gegevens, sturen we de gratis batterij dan zo snel mogelijk en binnen 30 dagen naar je toe.

ACCU BOORHAMERS SDS-PLUS

DHR243RTJ / DHR243RTJV

PROMO



DHR243RTJ

HEPA

DHR243RTJV filter

De afzuigunit bevat een aanzuigwaaier voor actieve stofafzuiging, aangedreven door een eigen motor die gevoed wordt door de accu van de boorhamer en enkele seconden blijft nalopen na het stopzetten van de boorhamer om alle reststof op te zuigen.



DHR243RTJV

18V

18V MAXIMUM



PROMO
Laser-afstandsmeter
LD030P
ter waarde van €



	DHR243RTJ	DHR243RTJV
Batterijcapaciteit	18 V / 5,0 Ah	18 V / 5,0 Ah
Gemiddelde oplaadtijd	45 min.	45 min.
Slagenergie	2 J	2 J
Optimale Ø beton	6 - 16 mm	6 - 16 mm
Aantal accu's	2 x BL1850	2 x BL1850
Gewicht	3,4 kg	4,8 kg
Opvolger van	DHR243RJM-	DHR243RMJV-
Prijs in €	Excl. BTW	
	Incl. BTW	

COMBOPACK 10,8V

CLX202SAX2

NIEUW



		CLX202SAX2
Batterijcapaciteit		10,8 V / 2,0 Ah
Gemiddelde oplaadtijd		30 min.
Aantal accu's		3 x BL1020B
Slagschroevendraaier		TD110D
klopboormachine		HP331D
Batterijlader		DC10SA
Opvolger van		LCT303
Prijs in €	Excl. BTW	
	Incl. BTW	

COMBOPACK 10,8V

CLX400SAJ1

NIEUW



		CLX400SAJ1
Batterijcapaciteit		10,8 V / 2,0 Ah
Gemiddelde oplaadtijd		30 min.
Aantal accu's		3 x BL1020B
Slagschroevendraaier		TD110D
klopboormachine		HP331D
Cirkelzaag		HS301D
Reciprozaag		JR103D
Batterijlader		DC10SA
Opvolger van		DK1474
Prijs in €	Excl. BTW	
	Incl. BTW	

BREEKHAMERS SDS-MAX

HM0870C(V) / HM0871C(V) / HM1101C(V) / HM1111C(V) / HM1203C(V) / HM1213C(V) / HM1214C(V)

PROMO



HM1214C



PROMO
SDS-MAX
beitelset
ter waarde van €

CV modellen
inclusief
stofafzuigset

		HM0870C	HM0870CV	HM0871C	HM0871CV	HM1101C	HM1101CV
Prijs in €	Excl. BTW						
	Incl. BTW						

		HM1111C	HM1111CV	HM1203C	HM1203CV	HM1213C	HM1213CV	HM1214C	HM1214CV
Prijs in €	Excl. BTW								
	Incl. BTW								

BOOR- EN BREEKHAMERS SDS-MAX 3-FUNCTIES

HR3541FCX / HR4013C(V) / HR4511C(V) / HR5212C(V)

PROMO



HR4013CV

CV modellen
inclusief stofafzuigset



PROMO
Boor en- beitelhamer
HR2470FTP ter waarde van €

		HR3541FCX	HR4013C	HR4013CV	HR4511C	HR4511CV	HR5212C	HR5212CV
Prijs in €	Excl. BTW							
	Incl. BTW							

ACCU BOOR- EN SCHROEFMACHINES

MAK
PAC

14.4V 18V



XPT
EXTREME PROTECTION TECHNOLOGY

L.E.D.

DHP481RT3J



XPT
EXTREME PROTECTION TECHNOLOGY

**BL
MOTOR**

DDF470RM3J

L.E.D.

**BL
MOTOR**

4.0Ah

PROMO

3^{de} ACCU

ter waarde van € (18V)
ter waarde van € (14,4V)



**DHP MET
KLOPBOORFUNCTIE**

XPT
EXTREME PROTECTION TECHNOLOGY



**BL
MOTOR**

DDF480RT3J

L.E.D.

XPT
EXTREME PROTECTION TECHNOLOGY



DDF482RM3J

L.E.D.

4.0Ah



XPT
EXTREME PROTECTION TECHNOLOGY

DHP448RM3J

L.E.D.

NIEUW

NIEUW

NIEUW

	DDF453RA3J	DDF482RM3J	DDF470RM3J	DDF480RT3J	DHP448RM3J	DHP481RT3J
Batterijcapaciteit	18 V / 2,0 Ah	18 V / 4,0 Ah	14,4 V / 4,0 Ah	18 V / 5,0 Ah	14,4 V / 4,0 Ah	18 V / 5,0 Ah
Gemiddelde oplaadtijd	24 min.	36 min.	36 min.	45 min.	36 min.	45 min.
Hard koppel	42 Nm	62 Nm	46 Nm	54 Nm	77 Nm	115 Nm
Boorkop	1,5 - 13 mm	1,5 - 13 mm	1,5 - 13 mm	1,5 - 13 mm	1,5 - 13 mm	1,5 - 13 mm
Aantal accu's	3 x BL1820	3 x BL1840	3 x BL1440	3 x BL1850	3 x BL1440	3 x BL1850
Gewicht	1,7 kg	1,7 kg	1,6 kg	1,8 kg	2,4 kg	2,4 kg
Opvolger van	DDF453RHE3	-	DDF446RM3J	DDF480SP1J	BHP448RFE3	DHP481SP1J
Prijs in €	Excl. BTW					
	Incl. BTW					

ACCU BOOR- EN SCHROEFMACHINES



14.4V

18V



DHP470
DHP480
DDF459

DHP470
DHP480

**DHP MET
KLOPBOORFUNCTIE**



DHP480RTJ



NIEUW

NIEUW

	DDF343RYJ	DHP453RFJ	DHP470RMJ	DDF459RMJ	DHP480RTJ
Batterijcapaciteit	14,4 V / 1,5 Ah	18 V / 3,0 Ah	14,4 V / 4,0 Ah	18 V / 4,0 Ah	18 V / 5,0 Ah
Gemiddelde oplaadtijd	15 min.	22 min.	36 min.	36 min.	45 min.
Hard koppel	36 Nm	42 Nm	46 Nm	45 Nm	54 Nm
Boorkop	1 - 10 mm	1,5 - 13 mm	1,5 - 13 mm	1,5-13 mm	1,5-13 mm
Aantal accu's	2 x BL1415N	2 x BL1830	2 x BL1440	2 x BL1840	2 x BL1850
Gewicht	1,4 kg	1,8 kg	1,7 kg	1,7 kg	1,9 kg
Opvolger van	BDF343RHJ	DHP453RAJ	-	-	DHP480RMJ
Prijs in €	Excl. BTW				
	Incl. BTW				



Stof- en waterbestendig

Diverse constructiedetails zoals een volledig waterdichte schakelaar, een interne dichting die de batterij afschermt en in hars gegoten elektronische circuits staan garant voor de beste stof- en waterbestendigheid op de markt.

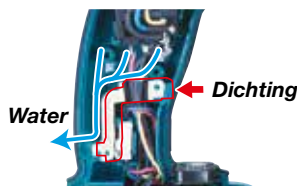

**+ 50%
Werkingsduur**

Onderhoudsvrije koolborstelloze motor met elektronische sturing levert meer koppel, behoudt de volle kracht bij linksom draaien en verzet meer werk met dezelfde accucapaciteit.



COMBI-SET MET ACCU BOOR- EN SCHROEFMACHINE

14.4V

		DDF343RYX2
Batterijcapaciteit		14,4 V / 1,5 Ah
Gemiddelde oplaadtijd		15 min.
Hard koppel		36 Nm
Boorkop		1 - 10 mm
Aantal accu's		2 x BL1415N
Gewicht		1,4 kg
Opvolger van		BDF343RHX2
Prijs in €	Excl. BTW	
	Incl. BTW	

INCLUSIEF
59 ACCESSOIRES



COMBI-SET MET ACCU BOOR- EN SCHROEFMACHINE

18V

INCLUSIEF
96 ACCESSOIRES



		DHP453RFX2
Batterijcapaciteit		18 V / 3 Ah
Gemiddelde oplaadtijd		22 min.
Hard koppel		42 Nm
Boorkop		1,5 - 13 mm
Aantal accu's		2 x BL1830
Gewicht		1,7 kg
Opvolger van		DHP453RYX2
Prijs in €	Excl. BTW	
	Incl. BTW	

COMBINATIEKIT MET ACCU BOOR- EN SCHROEFMACHINE

14.4V

Ni-Cd



INCLUSIEF
59 ACCESSOIRES



		8281DWPET3
Batterijcapaciteit		14,4 V / 1,3 Ah
Gemiddelde oplaadtijd		30 min.
Hard koppel		36 Nm
Boorkop		1-10 mm
Aantal accu's		2 x PA14
Gewicht		1,6 kg
Prijs in €	Excl. BTW	
	Incl. BTW	

ACCU BOORHAMERS SDS-PLUS

DHR243RTJ

DHR165RMJ

18V



PROMO
USB adapter voor
18V - 14,4V batterij
ter waarde van €

PROMO
Laser-afstandsmeter
LD030P ter waarde van
€ bij DHR243



DHR243RTJV

HEPA

DHR243RTJV filter

De afzuigunit bevat een aanzuigwaaier voor actieve stofafzuiging, aangedreven door een eigen motor die gevoed wordt door de accu van de boorhamer en enkele seconden blijft nalopen na het stopzetten van de boorhamer om alle reststof op te zuigen.

NIEUW

	DHR165RMJ	DHR202RTJ	DHR243RTJ	DHR243RTJV
Batterijcapaciteit	18 V / 4,0 Ah	18 V / 5,0 Ah	18 V / 5,0 Ah	18 V / 5,0 Ah
Gemiddelde oplaadtijd	36 min.	45 min.	45 min.	45 min.
Slagenergie	1,3 J	2 J	2 J	2 J
Optimale Ø beton	6 - 8 mm	6 - 10 mm	6 - 16 mm	6 - 16 mm
Aantal accu's	2 x BL1840	2 x BL1850	2 x BL1850	2 x BL1850
Gewicht	2,5 kg	3,5 kg	3,4 kg	4,8 kg
Opvolger van	-	DHR202RMJ	-	-
Prijs in €	Excl. BTW			
	Incl. BTW			

ACCU BOOR- EN BEITELHAMER LXT 2X18V VOOR SDS-PLUS 3 FUNCTIES

36V

INCLUSIEF
1 automatische
boorkop
(194079-2)



NIEUW

INCLUSIEF
Duo snellader DC18RD



		DHR264PT2J
Batterijcapaciteit		2 x 18V / 5,0 Ah
Gemiddelde oplaadtijd		2 x 45 min.
Slagenergie		2,5 J
Optimale Ø beton		6 - 16 mm
Aantal accu's		2 x BL1850
Gewicht		4,7 kg
Opvolger van		DHR264PM2J
Prijs in €	Excl. BTW	
	Incl. BTW	

ACCU BOOR- EN BEITELHAMER SDS-PLUS 3 FUNCTIES



BHR262RDJ

INCLUSIEF
1 automatische boorop
(194079-2) bij
BHR262TRDJ

	BHR262RDJ	BHR262TRDJ
Batterijcapaciteit	36 V / 2,6 Ah	36 V / 2,6 Ah
Gemiddelde oplaadtijd	22 min.	22 min.
Slagenergie	2,5 J	2,5 J
Optimale Ø beton	6 - 16 mm	6 - 16 mm
Aantal accu's	2 x BL3626	2 x BL3626
Gewicht	4,6 kg	4,8 kg
Prijs in €	Excl. BTW	
	Incl. BTW	

ACCU SLAGSCHROEVENDRAAIERS



DTD137RMJ
DTD148RMJ
DTD129RMJ

DTD137RMJ
DTD148RMJ
DTD134RMJ



DTD148RTJ



DTD129RTJ



PROMO
3de ACCU
bij DTD152RM3J &
DTD148RTJ

DTD152RM3J

Koppelinstelling	DTD137	DTD148
1 (Laag)	20 Nm	20 Nm
2 (Middel)	50 Nm	50 Nm
3 (Maximum)	170 Nm	175 Nm



	DTD152RM3J	DTD129RTJ	DTD134RMJ	DTD137RMJ	DTD148RTJ
Batterijcapaciteit	18 V / 4,0 Ah	18 V / 5,0Ah	14,4 V / 4,0 Ah	14,4 V / 4,0 Ah	18 V / 5,0 Ah
Gemiddelde oplaadtijd	36 min.	45 min.	36 min.	36 min.	45 min.
Toerental	0-2900 t.p.m.	0-2500 t.p.m.	0-2400 t.p.m.	0-3400 t.p.m.	0-3200 t.p.m.
Hard koppel / Bitopname	165 Nm / 1/4" hex.	160 Nm / 1/4" hex.	155 Nm / 1/4" hex.	170 Nm / 1/4" hex.	175 Nm / 1/4" hex.
Aantal accu's	3 x BL1840	2 x BL1850	2 x BL1440	2 x BL1440	2 x BL1850
Gewicht	1,5 kg	1,3 kg	1,4 kg	1,4 kg	1,5 kg
Opvolger van	-	DTD129RMJ	-	-	DTD148RMJ
Prijs in €	Excl. BTW				
	Incl. BTW				

ACCU HYBRIDE SLAGSCHROEVENDRAAIER



PROMO
USB adapter voor
18V - 14,4V batterij
ter waarde van €

	DTP141RMJ
Batterijcapaciteit	18 V / 4,0 Ah
Gemiddelde oplaadtijd	36 min.
Toerental	0-2700 t.p.m.
Aantal accu's	2 x BL1840
Gewicht	1,8 kg
Opvolger van	BTP141RFE
Prijs in €	Excl. BTW
	Incl. BTW

4 mode:
klobboren, boren
schroeven, slagschroeven

HYDRAULISCHE ACCU IMPULSSCHROEVENDRAAIERS



DTS141RMJ

PROMO
USB adapter voor 18V - 14,4V
batterij ter waarde van €
bij DTS141RMJ

	DTS130RMJ	DTS141RMJ
Batterijcapaciteit	14,4 V / 4,0 Ah	18 V / 4,0 Ah
Gemiddelde oplaadtijd	36 min.	36 min.
Toerental	0-2400 t.p.m.	0-2700 t.p.m.
Hard koppel / Bitopname	30 Nm / 1/4" hex.	40 Nm / 1/4" hex.
Aantal accu's	2 x BL1440	2 x BL1840
Gewicht	1,8 kg	1,5 kg
Opvolger van	BTS130RFJ	-
Prijs in €	Excl. BTW	
	Incl. BTW	

ACCU HAAKSE BOORMACHINES

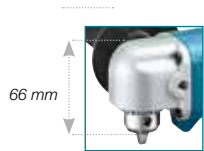

DDA340RMJ
DDA350RMJ



DDA341RMJ
DDA351RMJ



DDA351RMJ



DDA350RMJ

	DDA340RMJ	DDA341RMJ	DDA350RMJ	DDA351RMJ
Batterijcapaciteit	14,4 V / 4,0 Ah	14,4 V / 4,0 Ah	18 V / 4,0 Ah	18 V / 4,0 Ah
Gemiddelde oplaadtijd	36 min.	36 min.	36 min.	36 min.
Toerental	0-1700 t.p.m.	0-1700 t.p.m.	0-1800 t.p.m.	0-1800 t.p.m.
Hard koppel	10.3 Nm	10.3 Nm	13.7 Nm	13.7 Nm
Boorkop	1,5-10 mm	1,5-10 mm	1,5-10 mm	1,5-10 mm
Aantal accu's	2 x BL1440	2 x BL1440	2 x BL1840	2 x BL1840
Gewicht	1,7 kg	1,7 kg	1,8 kg	1,8 kg
Opvolger van	BDA340RFJ	-	-	-
Prijs in €	Excl. BTW			
	Incl. BTW			

ACCU HAAKSE SLAGSCHROEVENDRAAIER



DTL061RTJ

Batterijcapaciteit	18 V / 5,0 Ah
Gemiddelde oplaadtijd	45 min.
Toerental	0-2000 t.p.m.
Aantal accu's	2 x BL1850
Gewicht	1,8 kg
Opvolger van	DTL061RMJ
Prijs in €	Excl. BTW
	Incl. BTW

ACCU SLAGMOERSLEUTELS



DTW280RMJ DTW280RMJ
DTW281RMJ DTW281RMJ
DTW1001RTJ



DTW1001RTJ



DTW281RTJ

Koppelinstelling	DTW280	DTW281
1 (Laag)	80 Nm	80 Nm
2 (Middel)	175 Nm	175 Nm
3 (Maximum)	275 Nm	280 Nm

Drie-traps elektronische snelheidskeuze

NIEUW

NIEUW

NIEUW

	DTW280RMJ	DTW281RTJ	DTW450RTJ	DTW1001RTJ
Batterijcapaciteit	14,4 V / 4,0 Ah	18 V / 5,0 Ah	18 V / 5,0 Ah	18 V / 5,0 Ah
Gemiddelde oplaadtijd	36 min.	45 min.	45 min.	45 min.
Toerental	0-2200 t.p.m.	0-2100 t.p.m.	1600 t.p.m.	1600 t.p.m.
Hard koppel / Bitopname	275 Nm / 1/2" vierkant	280 Nm / 1/2" vierkant	440 Nm / 1/2" vierkant	1050 Nm / 3/4" vierkant
Aantal accu's	2 x BL1440	2 x BL1850	2 x BL1850	2 x BL1850
Gewicht	1,6 kg	1,7 kg	3,5 kg	3,4 kg
Opvolger van	-	DTW281RMJ	DTW450RMJ	-
Prijs in €	Excl. BTW			
	Incl. BTW			

ACCU SCHROEFAUTOMATEN



DFR540RMJ
DFR550RMJ

DFR550RMJ



	DFR540RMJ	DFR550RMJ	DFR750RME
Batterijcapaciteit	14,4 V / 4,0 Ah	18 V / 4,0 Ah	18 V / 4,0 Ah
Gemiddelde oplaadtijd	36 min.	36 min.	36 min.
Toerental	4000 t.p.m.	4000 t.p.m.	4000 t.p.m.
Ø Gipsplaatschroef	4,2 mm	4,2 mm	4,2 mm
Schroeflengte	25-55 mm	25-55 mm	45-75 mm
Aantal accu's	2 x BL1440	2 x BL1840	2 x BL1840
Gewicht	2,1 kg	2,2 kg	2,1 kg
Opvolger van	BFR540RFJ	BFR550RFJ	BFR750RFE
Prijs in €	Excl. BTW		
	Incl. BTW		

PROMO
Schuurmachine
ter waarde van €
bij DFR550RMJ



ACCU AFWERKINGSPISTOOL



DPT351RMJ

Batterijcapaciteit	18 V / 4,0 Ah
Gemiddelde oplaadtijd	36 min.
Doorsnede nagel	0,6 mm
Lengte niet	18-35 mm
Aantal accu's	2 x BL1840
Gewicht	2,1 kg
Opvolger van	BPT351RMJ
Prijs in €	Excl. BTW
	Incl. BTW

ACCU MINIBRADPISTOOL



PROMO

USB adapter voor 18V - 14,4V batterij ter waarde van €

		DBN500RMJ
Batterijcapaciteit		18 V / 4,0 Ah
Gemiddelde oplaadtijd		36 min.
Doorsnede nagel		1,2 mm
Lengte nagel		15-50 mm
Aantal accu's		2 x BL1840
Gewicht		3,5 kg
Prijs in €	Excl. BTW	
	Incl. BTW	

ACCU SCHROEVENDRAAIERS



DFS452RAJ

		DFS452RAJ
Batterijcapaciteit		18 V / 2,0 Ah
Gemiddelde oplaadtijd		24 min.
Toerental		0-4000 t.p.m.
Aantal accu's		2 x BL1820
Gewicht		1,7 kg
Opvolger van		DFS451RMJ
Prijs in €	Excl. BTW	
	Incl. BTW	

ACCU NIETMACHINES



DST220RMJ
DST221RMJ



BST110RFE



	BST110RFE	DST220RMJ	DST221RMJ
Batterijcapaciteit	14,4 V / 3,0 Ah	14,4 V / 4,0 Ah	18 V / 4,0 Ah
Gemiddelde oplaadtijd	22 min.	36 min.	36 min.
Rugbreedte niet	10 mm	10,5 mm	10,5 mm
Lengte niet	7-10 mm	10-22 mm	10-22 mm
Aantal accu's	2 x BL1430	2 x BL1440	2 x BL1840
Gewicht	2 kg	2,3 kg	2,4 kg
Opvolger van	-	BST220RFJ	BST221RFJ
Prijs in €	Excl. BTW		
	Incl. BTW		

ACCU HANDCIKSELZAAG



INCLUSIEF Duo snellader DC18RD



NIEUW

		DHS710PT2J
Batterijcapaciteit		18 V / 5,0 Ah
Gemiddelde oplaadtijd		2 x 45 min.
Zaagdiepte (45°)		49 mm
Ø Zaagblad		190 mm
Aantal accu's		2 x BL1850
Gewicht		4,7 kg
Opvolger van		DHS710PM2J
Prijs in €	Excl. BTW	
	Incl. BTW	

ACCU HANDCIKSELZAGEN



DCS551RTJ

DCS551RTJ voor metaal

PROMO
USB adapter voor 18V - 14,4V batterij ter waarde van €



DSS501RMJ

NIEUW

	Best. Nr.	Omschrijving	Prijs Excl. BTW	Prijs Incl. BTW
	B-47151	TCT zaagblad 150x20x32T		
	B-47167	TCT zaagblad 150x20x52T		
	B-47173	TCT zaagblad 150x20x60T		
	B-47189	TCT zaagblad 150x20x62T		

	DSS501RMJ	DCS551RTJ	DHS680RTJ	DHS630RTJ
Batterijcapaciteit	18 V / 4,0 Ah	18 V / 5,0 Ah	18 V / 5,0 Ah	18 V / 5,0 Ah
Gemiddelde oplaadtijd	36 min.	45 min.	45 min.	45 min.
Zaagdiepte (90°)	51 mm	51 mm	57 mm	66 mm
Ø Zaagblad	136 mm	150 mm	165 mm	165 mm
Aantal accu's	2 x BL1840	2 x BL1850	2 x BL1850	2 x BL1850
Gewicht	2,7 kg	2,9 kg	3,3 kg	3,5 kg
Opvolger van	-	DCS550RMJ	DSS610RMJ	-
Prijs in €	Excl. BTW			
	Incl. BTW			

ACCU DECOUPEERZAGEN

PROMO

USB adapter voor
18V - 14,4V batterij
ter waarde van €



NIEUW **NIEUW**

	DJV181RTJ	DJV182RTJ
Batterijcapaciteit	18 V / 5,0 Ah	18 V / 5,0 Ah
Gemiddelde oplaadtijd	45 min.	45 min.
Aantal zaagbewegingen	800 - 3500 min ⁻¹	800 - 3500 min ⁻¹
Maximale capaciteit hout	135 mm	135 mm
Aantal accu's	2 x BL1850	2 x BL1850
Gewicht	2,5 kg	2,5 kg
Opvolger van	DJV181RMJ	DJV182RMJ
Prijs in €	Excl. BTW	
	Incl. BTW	

ACCU RECIPROZAGEN



18V

DJR183RTJ



NIEUW

	DJR183RTJ	DJR181RTE
Batterijcapaciteit	18 V / 5,0 Ah	18 V / 5,0 Ah
Gemiddelde oplaadtijd	45 min.	45 min.
Aantal zaagbewegingen	0-3300 /min.	2900 /min.
Maximale capaciteit hout	50 mm	255 mm
Aantal accu's	2 x BL1850	2 x BL1850
Gewicht	1,6 kg	3,7 kg
Opvolger van	DJR183RMJ	DJR181RME
Prijs in €	Excl. BTW	
	Incl. BTW	

ACCU LINTZAAG

18V



64 mm

ACCESSOIRES DPB181RME BI-METAAL ZAAGBLADEN

Geschikt voor plastic, gelegeerd en niet gelegeerd staal, inox, aluminium en composietmateriaal.



Breedte: 13 mm, Lengte: 835 mm,
Dikte: 0,5 mm
5 stuks per verpakking

B-40543 - Tandafstand 1,8 mm
€ 50,00 excl. BTW

B-40559 - Tandafstand 1,4 mm
€ 50,00 excl. BTW

B-40565 - Tandafstand 1,1 mm
€ 50,00 excl. BTW

DPB181RME	
Batterijcapaciteit	18 V / 4,0 Ah
Gemiddelde oplaadtijd	36 min.
Bandsnelheid max.	3,2m / min.
Aantal accu's	2 x BL1840
Gewicht	3,2 kg
Prijs in €	Excl. BTW
	Incl. BTW

TELESCOPISCHE DUBBELVERSTEKZAAG OP ACCU

18V

INCLUSIEF
Duo snellader DC18RD



NIEUW



DLS714PT2	
Batterijcapaciteit	18 V / 5,0 Ah
Gemiddelde oplaadtijd	45 min.
Zaagdiepte (90°)	52 mm
Zaagbreedte (90°)	300 mm
Ø Zaagblad	190 mm
Aantal accu's	2 x BL1850
Gewicht	13,0 kg
Opvolger van	DLS713RME
Prijs in €	Excl. BTW
	Incl. BTW

ACCU LAMELLENFREES



DPJ180RMJ	
Batterijcapaciteit	18 V / 4,0 Ah
Gemiddelde oplaadtijd	36 min.
Toerental	6500 t.p.m.
Aantal accu's	2 x BL1840
Gewicht	3,2 kg
Opvolger van	BJP180RFE
Prijs in €	Excl. BTW
	Incl. BTW

ACCU SCHAAF



PROMO

USB adapter voor
18V - 14,4V batterij
ter waarde van €



DKP180RMJ	
Batterijcapaciteit	18 V / 4,0 Ah
Gemiddelde oplaadtijd	36 min.
Toerental	14000 t.p.m.
Maximale schaaftbreedte	82 mm
Aantal accu's	2 x BL1840
Gewicht	3,4 kg
Opvolger van	BKP180RFE
Prijs in €	Excl. BTW
	Incl. BTW

ACCU KITPISTOLEN

300 ml

600 ml

300 ml

DCG180RA

DCG180RAX

INCLUSIEF
kokerhouder
bij DCG180RAX

		DCG180RA	DCG180RAX
Batterijcapaciteit		18 V / 2,0 Ah	18 V / 2,0 Ah
Gemiddelde oplaadtijd		24 min.	24 min.
Maximale spuitdruk		5000N	5000N
Toerental max.		0-28 mm/sec	0-28 mm/sec
Aantal accu's		1 x BL1820	1 x BL1820
Gewicht		2,1 kg	2,4 kg
Opvolger van		DCG180RH	-
Prijs in €	Excl. BTW		
	Incl. BTW		

MULTIFUNCTIONEEL OSCILLEREND GEREEDSCHAP

MAK PAC **L.I.E.D.** **18V**

OIS

NIEUW

Accessoires zie pagina: 56

INCLUSIEF:
Set van 9 accessoires,
30 schuurvellen,
1 afzuigset

**Gereedschapsloze
accessoirewissel**

		DTM51RTJX2
Batterijcapaciteit		18 V / 5,0 Ah
Gemiddelde oplaadtijd		45 min.
Toerental		6000-20000 /min.
Oscillatiehoek		3,2°
Aantal accu's		2 x BL1850
Opvolger van		DTM51RMJX2
Prijs in €	Excl. BTW	
	Incl. BTW	

ACCU EXCENTERSCHUURMACHINE 125MM

MAK PAC **18V**

NIEUW

		DBO180RTJ
Batterijcapaciteit		18 V / 5,0 Ah
Gemiddelde oplaadtijd		45 min.
Aantal schuurbewegingen		11000 /min.
Schuurvoet		123 mm
Aantal accu's		2 x BL1850
Gewicht		1,7 kg
Opvolger van		DBO180RMJ
Prijs in €	Excl. BTW	
	Incl. BTW	

ACCU HAAKSE SLIJPER



DGA508RTJ

DGA508RTJ & DGA505 zijn uitgerust met een lepelschakelaar



PROMO

5 x doorslijpschijven
ter waarde van €
bij DGA504RTJ1 & DGA505RTJ1



Komschijven

	Best. Nr.	Ø (mm)	Dikte (mm)	Ø asgat (mm)	Prijs	
					Excl. BTW	Incl. BTW
	B-46327	115	1,4	22, 23		
	B-46333	125	1,4	22, 23		

Doorslijpschijven
Metaal Inox

	Best. Nr.	Ø (mm)	Dikte (mm)	Ø asgat (mm)	Prijs	
					Excl. BTW	Incl. BTW
	B-45727	115	0,8	22, 23		
	B-45733	125	0,8	22, 23		

DGA506 & DGA508 met heropstartbeveiliging & elektrische rem



DGA506RTJ

NIEUW

		DGA504RTJ1	DGA506RTJ
Batterijcapaciteit		18 V / 5,0 Ah	18 V / 5,0 Ah
Gemiddelde oplaadtijd		45 min.	45 min.
Ø schijf		125 mm	125 mm
Aantal accu's		2 x BL1850	2 x BL1850
Gewicht		2,5 kg	2,5 kg
Opvolger van		-	DGA504RTJ
Prijs in €	Excl. BTW		
	Incl. BTW		

NIEUW

		DGA505RTJ1	DGA508RTJ
Batterijcapaciteit		18 V / 5,0 Ah	18 V / 5,0 Ah
Gemiddelde oplaadtijd		45 min.	45 min.
Ø schijf		125 mm	125 mm
Aantal accu's		2 x BL1850	2 x BL1850
Gewicht		2,5 kg	2,5 kg
Opvolger van		-	DGA505RTJ
Prijs in €	Excl. BTW		
	Incl. BTW		



ACCU STEPELSLIJPER



DGD800RTJ

Batterijcapaciteit	18 V / 5,0 Ah
Gemiddelde oplaadtijd	45 min.
Toerental	25000 t.p.m.
Ø spantang	8 mm
Aantal accu's	2 x BL1850
Gewicht	2,1 kg
Opvolger van	-
Prijs in €	Excl. BTW
	Incl. BTW

ACCU KNABELSCHAAR



DJN161RMJ

Batterijcapaciteit	18 V / 4,0 Ah
Gemiddelde oplaadtijd	36 min.
Aantal snijbewegingen max.	1900 /min.
Max. dikte staal	1,6 mm
Aantal accu's	2 x BL1840
Gewicht	2,2 kg
Opvolger van	BJN161RFE
Prijs in €	Excl. BTW
	Incl. BTW

PROMO

USB adapter voor
18V - 14,4V batterij
ter waarde van €





ACCU PLAATSCHAAR



PROMO
USB adapter voor
18V - 14,4V batterij
ter waarde van €

BJS130RFE

Batterijcapaciteit	18 V / 3,0 Ah
Gemiddelde oplaadtijd	22 min.
Aantal zaagbewegingen	2800 /min.
Max. dikte staal	1,3 mm
Aantal accu's	2 x BL1830
Gewicht	2,4 kg
Prijs in €	Excl. BTW
	Incl. BTW

HYDRAULISCHE BETONIJZERKNIPPER



DSC191RM

	DSC162RM	DSC191RM
Batterijcapaciteit	18V / 4,0 Ah	18V / 4,0 Ah
Gemiddelde oplaadtijd	36 min.	36 min.
Maximale snijcapaciteit	16 mm	20 mm
Aantal accu's	1 x BL1840	1 x BL1840
Gewicht	6,5 kg	10,5 kg
Prijs in €	Excl. BTW	
	Incl. BTW	

ACCU BETONTRILNAALDEN



DVR850RTE

NIEUW

	DVR350RME	DVR450RME	DVR850RTE
Batterijcapaciteit	18 V / 4,0 Ah	18 V / 4,0 Ah	18 V / 5,0 Ah
Gemiddelde oplaadtijd	36 min.	36 min.	45 min.
Lengte trilnaald	80 cm	120 cm	240 cm
Diameter trilnaald	25 mm	25 mm	25 mm
Aantal accu's	2 x BL1840	2 x BL1840	2 x BL1850
Gewicht	2 kg	2,3 kg	2,4 kg
Opvolger van	BVR350RFE	BVR450RFE	BVR850RME
Prijs in €	Excl. BTW		
	Incl. BTW		

PROMO
USB adapter voor
18V - 14,4V batterij ter waarde
van € bij DVR350 & DVR450



DLX2061MJ1

€ Excl. BTW
€ Incl. BTW

PRO
2x



DTD129

18V

DC18RC



DLX2121J

€ Excl. BTW
€ Incl. BTW

Opvolger van
DLX2121AJ



DLX2000TJ

€ Excl. BTW
€ Incl. BTW

Opvolger van
DLX2000MJ

DC18RC

PROMO
neusstuk
ter waarde van €



NIEUW

DLX2040TJ1

€ Excl. BTW
€ Incl. BTW

Opvolger van
DLX2040SP



DLX2128TJ1

€ Excl. BTW
€ Incl. BTW



DTD129



BL1850



DDF480

DHR264

DC18RD

18V LITHIUM-ION **4.0Ah**

DLX2065PMJ

€ Excl. BTW
€ Incl. BTW

PROMO

USB adapter voor
18V - 14,4V batterij
ter waarde van €
bij DLX2065 & DLX2067



DDF480

DHS710

DC18RD

18V LITHIUM-ION **4.0Ah**

DLX2067PMJ

€ Excl. BTW
€ Incl. BTW



DDF482

BL1840

NIEUW

18V LITHIUM-ION **4.0Ah**

DLX2127MJ1

€ Excl. BTW
€ Incl. BTW

DTD152

DC18RC

18V LITHIUM-ION 40Ah

DLX5017MJ

€ Excl. BTW
€ Incl. BTW



DHR243



DGA504

NIEUW



DHS680



DC18RC



DHP481



BL1840



DTD129

PRO

5 X door-
slijpschijven



DHP481

BL1840



DC18RC

18V LITHIUM-ION 4.0Ah

DHR243



DDF480



DC18RC



BL1840

DLX2052MJ

€ Excl. BTW
€ Incl. BTW

DLX2129TJ1

€ Excl. BTW
€ Incl. BTW

DC18RC



DTM51



DDF480



BL1850

NIEUW



COMBO

ter waarde van €



18V LITHIUM-ION **4.0Ah**

DLX2130MJ1

€ Excl. BTW
€ Incl. BTW



DGA504



DLX4050TJ

€ Excl. BTW
€ Incl. BTW
Opvolger van
DLX4050MJ

DLX6030MJ1

€ Excl. BTW
€ Incl. BTW

Opvolger van
DLX6020MJ1

18V LITHIUM-ION **4.0Ah**



DGA504

DHR243

DHP481

DTM51

DC18RC

DHS680

DTD129

18V LITHIUM-ION **4.0Ah**

DLX1002MJ1

€ Excl. BTW
€ Incl. BTW



DDA351

DJR183

DBO180

DGA504

DHR243

DHP481

DTM51

DC18RC

DHS680

DTD129

DJV181

HET **LXT** LITHIUM-ION PLATFORM

Vervolledig uw Li-Ion gereedschap dankzij het grote assortiment machines zonder accu's en lader.



18V
DTD148ZJ
€ Excl. BTW
€ Incl. BTW



18V
DDF480ZJ
€ Excl. BTW
€ Incl. BTW



18V
DHP481ZJ
€ Excl. BTW
€ Incl. BTW



18V
DFR750ZK
€ Excl. BTW
€ Incl. BTW



18V
DJR183ZJ
€ Excl. BTW
€ Incl. BTW



18V
DTS141ZJ
€ Excl. BTW
€ Incl. BTW



18V
DUB182Z
€ Excl. BTW
€ Incl. BTW



18V
DCL182Z
€ Excl. BTW
€ Incl. BTW



18V
DCM500Z
€ Excl. BTW
€ Incl. BTW



18V
DCF300Z
€ Excl. BTW
€ Incl. BTW



18V
DBO180ZJ
€ Excl. BTW
€ Incl. BTW



18V
DSC162Z
€ Excl. BTW
€ Incl. BTW



18V
DSC191Z
€ Excl. BTW
€ Incl. BTW



14.4V & 18V
DMR102
€ Excl. BTW
€ Incl. BTW



14.4V & 18V
DMR106B
€ Excl. BTW
€ Incl. BTW



36V
DHR264ZJ
€ Excl. BTW
€ Incl. BTW



36V
DHS710ZJ
€ Excl. BTW
€ Incl. BTW



36V
BHR262TZJ
€ Excl. BTW
€ Incl. BTW



18V
DLS714Z
€ Excl. BTW
€ Incl. BTW

NIEUW



18V
DVC860LZ
€ Excl. TVA
€ Incl. TVA

GELEVERD ZONDER ACCU EN LADER



STEXBML184 Zaklamp
Accuspanning: 14,4V - 18V
Werkingsduur: 200 minuten

14.4V 18V

€ Excl. BTW
€ Incl. BTW



STEXBML801 Zaklamp
Accuspanning: 14,4V - 18V
Werkingsduur: 9 uur

14.4V 18V

€ Excl. BTW
€ Incl. BTW



14.4V 18V

STEXBML185 Zaklamp
Accuspanning: 14,4V - 18V
Werkingsduur: 260 minuten

€ Excl. BTW
€ Incl. BTW



14.4V 18V

STEXBML186 Zaklamp
Accuspanning: 14,4V - 18V
Werkingsduur: 260 minuten

€ Excl. BTW
€ Incl. BTW



14.4V 18V

DEADML802 Zaklamp
Accuspanning: 14,4V - 18V
Werkingsduur: 13 uur

€ Excl. BTW
€ Incl. BTW



14.4V 18V

DEABML803 Zaklamp
Accuspanning: 14,4V - 18V
Werkingsduur: 16-24 uur

€ Excl. BTW
€ Incl. BTW



36V
STEXBML360 Zaklamp
Accuspanning: 36V
Werkingsduur: 210 min.



14.4V 18V

BCF050Z Ventilator voor helm
Li-Ion 14,4V - 18V

€ Excl. BTW
€ Incl. BTW



10.8V
STEXMR051
Radio Li-Ion 10,8V

€ Excl. BTW
€ Incl. BTW

€ Excl. BTW
€ Incl. BTW

BATTERIJ BL1020B 10,8V 197394-3



€ Excl. BTW
€ Incl. BTW

BATTERIJ BL1040B 10,8V 197402-0



€ Excl. BTW
€ Incl. BTW

OPLADER DC10SA 197355-3



€ Excl. BTW
€ Incl. BTW

POWER PACK 10,8V 2.0Ah 197657-7



€ Excl. BTW
€ Incl. BTW

POWER PACK 10,8V 4.0Ah 197636-5



€ Excl. BTW
€ Incl. BTW

DUAL CHARGER / DUBBELLADER DC18RD 196933-6

2 batterijen BL1830
laden in 22 minuten



€ Excl. BTW
€ Incl. BTW

TWIN PACK 18V 4.0Ah 196405-1



€ Excl. BTW
€ Incl. BTW

TWIN PACK 18V 5.0Ah 196680-9



€ 249,00 Excl. BTW
€ 301,29 Incl. BTW

USB ADAPTER 14,4 / 18V DEADP05



€ 25,00 Excl. BTW
€ 30,25 Incl. BTW

POWER PACK 18V 4.0Ah 196866-5



€ Excl. BTW
€ Incl. BTW

LED WERKLAMP DEADML805



€ Excl. BTW
€ Incl. BTW

POWER PACK 18V 4.0Ah 197433-9



€ Excl. BTW
€ Incl. BTW

STATIEF DML805 GM00001381



€ Excl. BTW
€ Incl. BTW

POWER PACK 18V 5.0Ah 197629-2



€ Excl. BTW
€ Incl. BTW

SPANVIJS DML805 GM00001396



€ Excl. BTW
€ Incl. BTW

ACCU PENPACT SCHROEVENDRAAIER



		TD021DSE
Batterijcapaciteit		7,2 V / 1,0 Ah
Gemiddelde oplaadtijd		30 min.
Toerental		0-3000 t.p.m.
Hard koppel		22 Nm
Bitopname		1/4" hex.
Aantal accu's		2 x BL7010
Gewicht		0,5 kg
Prijs in €	Excl. BTW	
	Incl. BTW	

ACCU BOOR- EN SCHROEFMACHINE



DF330DWE



		DF330DWE
Batterijcapaciteit		10,8 V / 1,3 Ah
Gemiddelde oplaadtijd		50 min.
Hard koppel		24 Nm
Bitopname / Boorkop		1-10 mm
Aantal accu's		2 x BL1013
Gewicht		1 kg
Prijs in €	Excl. BTW	
	Incl. BTW	

ACCU HAAKSE BOORMACHINES



DA330DWE



66 mm

DA330DWE



DA331DWE

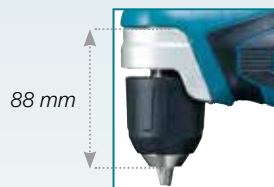

88 mm

DA331DWE



		DA330DWE	DA331DWE
Batterijcapaciteit		10,8 V / 1,3 Ah	10,8 V / 1,3 Ah
Gemiddelde oplaadtijd		50 min.	50 min.
Hard koppel		15 Nm	15 Nm
Boorkop		1,5-10 mm	0,8-10 mm
Aantal accu's		2 x BL1013	2 x BL1013
Gewicht		1,1 kg	1,2 kg
Prijs in €	Excl. BTW		
	Incl. BTW		

ACCU SLAGMOERSLEUTEL



TW100DWE		
Batterijcapaciteit	10,8 V / 1,3 Ah	
Gemiddelde oplaadtijd	50 min.	
Toerental	0-3000 t.p.m.	
Hard koppel	110 Nm	
Bitopname	3/8" carré	
Aantal accu's	2 x BL1013	
Gewicht	1 kg	
Prijs in €	Excl. BTW	
	Incl. BTW	



ACCU TEGEL EN- GLASSNIJDER

10.8V

CC300DWE		
Batterijcapaciteit	10,8 V / 1,3 Ah	
Gemiddelde oplaadtijd	50 min.	
Zaagdiepte (90°)	20 mm	
Ø Zaagblad	85 mm	
Aantal accu's	2 x BL1013	
Gewicht	1,7 kg	
Prijs in €	Excl. BTW	
	Incl. BTW	



COMBOPACK 10,8V

CLX202SAX2

NIEUW



CLX202SAX2		
Batterijcapaciteit	10,8 V / 2,0 Ah	
Gemiddelde oplaadtijd	30 min.	
Aantal accu's	3 x BL1020B	
Slagschroevendraaier	TD110D	
klopboormachine	HP331D	
Batterijlader	DC10SA	
Opvolger van	LCT303	
Prijs in €	Excl. BTW	
	Incl. BTW	

COMBOPACK 10,8V

DF331SAX1

NIEUW



DF331SAX1		
Batterijcapaciteit	10,8 V / 2,0 Ah	
Gemiddelde oplaadtijd	30 min.	
Aantal accu's	2 x BL1020B	
Batterijlader	DC10SA	
Hard koppel	30 Nm	
Gewicht	1,1 kg	
Prijs in €	Excl. BTW	
	Incl. BTW	

ACCU COMBOPACK



		DK1474X1
Batterijcapaciteit	10,8 V / 1,3 Ah	
Gemiddelde oplaadtijd	50 min.	
Boorschroefmachine	DF330D	
Slagschroevendraaier	TD090D	
Cirkelzaag	HS300D	
Wipzaag	JV100D	
Zaklamp	STEXML101	
Aantal accu's	3 x BL1013	
Stevige cordura werftas	✓	
Prijs in €	Excl. BTW	
	Incl. BTW	

ACCU CIRKELZAAG



		HS300DWE
Batterijcapaciteit	10,8 V / 1,3 Ah	
Gemiddelde oplaadtijd	50 min.	
Zaagdiepte (90°)	26 mm	
Ø Zaagblad	85 mm	
Aantal accu's	2 x BL1013	
Gewicht	1,5 kg	
Prijs in €	Excl. BTW	
	Incl. BTW	

ACCU WIPZAAG



		JV100DWE
Batterijcapaciteit	10,8 V / 1,3 Ah	
Gemiddelde oplaadtijd	50 min.	
Aantal zaagbewegingen	0-2400 /min.	
Maximale capaciteit hout	50 mm	
Aantal accu's	2 x BL1013	
Gewicht	1,7 kg	
Prijs in €	Excl. BTW	
	Incl. BTW	

ACCU RECIPROZAAG



		JR100DWE
Batterijcapaciteit	10,8 V / 1,3 Ah	
Gemiddelde oplaadtijd	50 min.	
Aantal zaagbewegingen	0-3300 /min.	
Maximale capaciteit hout	50 mm	
Aantal accu's	2 x BL1013	
Gewicht	1,2 kg	
Prijs in €	Excl. BTW	
	Incl. BTW	

STOFZUIGER MET GEINTEGREERDE ACCU



		CL104DWYX
Batterijcapaciteit	10,8 V / 1,5 Ah	
Gemiddelde oplaadtijd	3 h	
Max. debiet	1,1 m³/min	
Gewicht	1,3 kg	
Prijs in €	Excl. BTW	
	Incl. BTW	

ACCU STOFZUIGER



		CL102DW
Batterijcapaciteit	10,8 V / 1,3 Ah	
Gemiddelde oplaadtijd	50 min.	
Max. debiet	0,9 m³/min	
Max. onderdruk	23 mbar	
Aantal accu's	1 x BL1013	
Gewicht	1,1 kg	
Prijs in €	Excl. BTW	
	Incl. BTW	

MACCESS SERIES

200-delige boor- en schroefset

D-37194

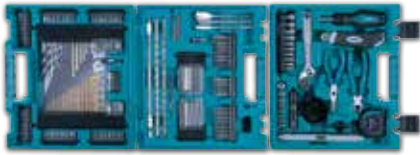

€ Excl. BTW
€ Incl. BTW

104-delige boor- en schroefset

D-31778



€ Excl. BTW
€ Incl. BTW

71-delige boor- en schroefset

D-33691



€ Excl. BTW
€ Incl. BTW

34-delige boor- en schroefset

D-36980



€ Excl. BTW
€ Incl. BTW

MAKPAC SERIES

69-delige boor- en schroefset in Makpac koffer B-49638



€ Excl. BTW
€ Incl. BTW

116-delige boor- en schroefset in Makpac koffer B-49884



€ Excl. BTW
€ Incl. BTW

SCHROEFBITSETS

47-delige 'standaard' schroefbitset

B-36170



Inhoud: 25mm 'standard' schroefbits 2x PH1, 2 x PH2, 2x PH3, 2x PZ1, 2 x PZ2, 2x PZ3, 2x T10, 2 x T15, 2 x T20, 2 x T25, 2 x T30, 2x T40, Hex2, Hex2,5, Hex3, 2x Hex4, 2x Hex5, 2x Hex6, 2x 0,6x4,5, 2x 1,0x5,5, 2x 1,2x6,5, een magnetische bithouder, dop sleutels 5/6/7/8/9/10/11mm en een bithandgreep.

€ Excl. BTW
€ Incl. BTW

11-delige 'standaard' schroefbits

D-30651



Inhoud: 25mm schroefbits PH1, PH2, PH3, PZ1, PZ2, PZ3, T15, T20, T25, T30 en een magnetische bithouder van 60mm.

€ Excl. BTW
€ Incl. BTW

12-delige 'standaard' schroefbits

D-31083



Inhoud: 25mm schroefbits PH1, PH2, PH3, PZ1, PZ2, PZ3, T10, T15, T20, T25, T30 en een magnetische bithouder van 60mm.

€ Excl. BTW
€ Incl. BTW

31-delige 'standaard' schroefbitset

D-30667



Inhoud: een 'quick-release' bithouder met 25mm 'standard' schroefbits 2x PH1, 4x PH2, 1x PH3, 2x PZ1, 5x PZ2, 1x PZ3, 2x T10, 2x T15, 2x T20, 3x T25, 2x T30, 1x T40, 1x 0,6x4,5, 1x 0,8x5,5 en 1x 1,2x6,5.

€ Excl. BTW
€ Incl. BTW

37-delige 'standaard' schroefbitset

B-28606



Inhoud: 25mm 'standard' schroefbits PH0, PH1, 2 x PH2, PH3, PZ0, PZ1, 2 x PZ2, PZ3, T10, 2 x T15, 2 x T20, 2 x T25, T27, 2 x T30, T40, TH10, TH15, TH20, TH25, TH27, TH30, TH40, Hex3, Hex4, Hex5, Hex6, 0,5x4, 0,6x4,5, 1,0x5,5, 1,2x6,5 en een magnetische bithouder.

€ Excl. BTW
€ Incl. BTW

Impact GOLD

Xtreme Torsion Technology

De impact Gold dopsleutel met ring
Snel en eenvoudig vastschroeven zonder metaalschijfers.
Niet-magnetische ringgrepen.



Dopsleutels voor draadstang 6 mm B-42961
Dopsleutels voor draadstang 8 mm B-42977
Dopsleutels voor draadstang 10 mm B-42983



€ Excl. BTW
€ Incl. BTW

Adapter 'Mag boost' B-42422



€ Excl. BTW
€ Incl. BTW

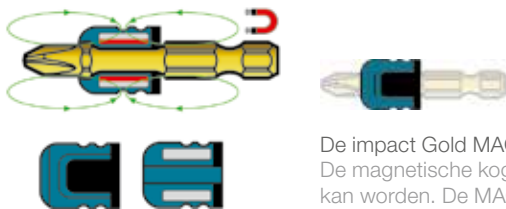

De impact Gold MAG Booster
De magnetische kogel die op de schroef werd gehecht zorgt ervoor dat er zonder een bithouder geschroefd kan worden. De MAG Booster is 17 keer sterker in vergelijking met de standaard magnetische bithouders.

Adapter 'Mag boost' + 5 bits B-42503



€ Excl. BTW
€ Incl. BTW

Impact gold adapter voor krachtdoppen 3/8" B-28547

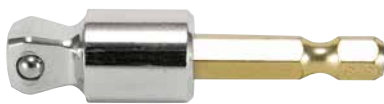

€ Excl. BTW
€ Incl. BTW

Impact gold adapter voor krachtdoppen 1/2" B-28553

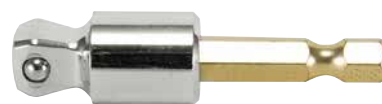

€ Excl. BTW
€ Incl. BTW

BORENSETS CILINDRISCHE SCHACHT

19-delige HSS-Co 5% metaalboren set.
Diameters: van 1 tot 10mm.

P-73710



€ Excl. BTW
€ Incl. BTW

25-delige HSS-Co 5% metaalboren set.
Diameters: van 1 tot 13mm.

P-73726



€ Excl. BTW
€ Incl. BTW

BOORHAMERS SDS-PLUS 2 FUNCTIES

		HR1830	HR2600	HR2800
Vermogen		440 Watt	800 Watt	800 Watt
Slagenergie		1,2 J	2,4 J	2,8 J
Optimale Ø beton		4 - 8 mm	6 - 18 mm	8 - 18 mm
Vibratieniveau hamerboren		14 m/s ²	15,5 m/s ²	20 m/s ²
Gewicht		1,9 kg	2,8 kg	3,4 kg
Prijs in €	Excl. BTW			
	Incl. BTW			

PROMO
boor -en beitelset
4 stuks bij HR1830
ter waarde van €





HR2600

HR2800



BOOR- EN BEITELHAMERS SDS-PLUS 3 FUNCTIES

AVT
AVT E-TECHNOLOGIES

HR2470FT
HR2631FT12
HR2811FT

L.E.D.

Anti-vibratie handgreep



HR2811FT



HR2631FT12



HR2630TX12

PROMO
boor -en beitelset
17 stuks bij HR2470FT,
HR2630TX12 & HR2631FT12
ter waarde van €



INCLUSIEF
1 automatische
boorkop (194079-2)
bij FT & TX modellen



		HR2470	HR2470FT	HR2630TX12	HR2631FT12	HR2811FT
Vermogen		780 Watt	780 Watt	800 Watt	800 Watt	800 Watt
Slagenergie		2,4 J	2,4 J	2,4 J	2,4 J	2,9 J
Optimale Ø beton		8 - 18 mm	8 - 18 mm	6 - 18 mm	6 - 18 mm	8 - 18 mm
Vibratieniveau hamerboren		15,5 m/s ²	15,5 m/s ²	15 m/s ²	11,5 m/s ²	15 m/s ²
Gewicht		3,0 kg	2,9 kg	2,9 kg	3 kg	3,6 kg
Opvolger van		-	-	HR2610TX9	HR2611FTX9	-
Prijs in €	Excl. BTW					
	Incl. BTW					

BOOR- EN BEITELHAMERS SDS-PLUS 3-FUNCTIES



HR3210FCT

INCLUSIEF
1 automatische
boorkop (194568-7)
bij HR3210FCT



HR3210FCT:
Anti-vibratie
handgreep

		HR3200C	HR3210FCT
Vermogen		850 Watt	850 Watt
Slagenergie		5,1 J	4,9 J
Optimale Ø beton		10 - 22 mm	10 - 22 mm
Vibratieniveau hamerboren		18 m/s ²	10 m/s ²
Gewicht		4,8 kg	5,4 kg
Prijs in €	Excl. BTW		
	Incl. BTW		

BETONBOREN NEMES SDS-PLUS

+ Efficiënter
+ Preciezer

+ Langere levensduur



Het solide uit 1 stuk vervaardigd hardmetalen boorpunt zorgt voor lage vibraties en optimale boorprestaties.

Best. Nr.	Ø (mm)	Lengte (mm)	Prijs	
			Excl. BTW	Incl. BTW
B-11623	5	110		
B-11639	5	160		
B-43016	5	210		
B-27252	5	260		
B-11645	5,5	110		
B-11651	5,5	160		
B-11667	6	110		
B-11673	6	160		
B-11689	6	210		
B-11695	6	260		
B-11704	6	310		
B-11710	6,5	160		
B-11726	6,5	210		
B-11732	6,5	260		
B-11748	6,5	310		
B-11754	7	110		
B-11760	7	160		
B-30134	7	210		
B-11776	8	110		
B-11782	8	160		
B-11798	8	210		
B-11807	8	260		
B-13328	8	310		
B-13708	8	460		
B-19869	9	160		
B-27268	9	260		
B-11813	10	110		
B-11829	10	160		
B-11835	10	210		
B-11841	10	260		
B-11857	10	310		
B-11863	10	450		
B-14174	10	600		
B-13334	10	1000		
B-20345	11	160		
B-20351	11	210		
B-20367	11	260		
B-20373	11	310		
B-11879	12	160		
B-11885	12	210		
B-11891	12	260		

Best. Nr.	Ø (mm)	Lengte (mm)	Prijs	
			Excl. BTW	Incl. BTW
B-11900	12	310		
B-11916	12	450		
B-14180	12	600		
B-13340	12	1000		
B-35396	13	160		
B-35405	13	210		
B-35411	13	260		
B-35427	13	310		
B-11922	14	160		
B-11938	14	210		
B-12429	14	260		
B-11944	14	310		
B-11950	14	450		
B-14196	14	600		
B-13356	14	1000		
B-14205	15	160		
B-14211	15	210		
B-14227	15	260		
B-14233	15	450		
B-13362	16	160		
B-13378	16	210		
B-13384	16	260		
B-13390	16	310		
B-13409	16	450		
B-14249	16	600		
B-13415	16	1000		
B-12055	18	250		
B-12061	18	450		
B-12077	20	250		
B-12083	20	450		
B-12186	22	250		
B-12099	22	450		
B-12108	24	250		
B-12114	24	450		
B-12120	25	250		
B-12136	25	450		
B-12142	28	250		
B-12158	28	450		
B-12164	30	250		
B-12170	30	450		
B-12192	32	450		

B-11994	assortiment van 5 beton boren SDS 4+ 4-force		
PROMO SPECIALE PRIJS	Prijs Excl. BTW €	Prijs Incl. BTW €	



BOOR- EN BREEKHAMERS AVT SDS-MAX 3 FUNCTIES



HR5212C

CV modellen
inclusief
stofafzuigset

PROMO
Boor en- beitelhamer
HR2470FTP
ter waarde van €



HR4013CV

Anti-vibratie handgreep		HR3541FCX	HR4013C	HR4013CV	HR4511C	HR4511CV	HR5212C	HR5212CV
Vermogen		850 watt	1100 Watt	1100 Watt	1350 Watt	1350 Watt	1500 Watt	1500 Watt
Slagenergie		5,7 J	8,0 J	8,0 J	9,4 J	9,4 J	18,9 J	18,9 J
Optimale Ø beton		14-25 mm	16-30 mm	16-30 mm	20-35 mm	20-35 mm	25-40 mm	25-40 mm
Vibratieniveau hamerboren		11 m/s ²	5,0 m/s ²	5,0 m/s ²	7,5 m/s ²	7,5 m/s ²	12,5 m/s ²	12,5 m/s ²
Gewicht		5,6 kg	6,8 kg	6,8 kg	8,8 kg	8,8 kg	12,1 kg	12,1 kg
Prijs in €	Excl. BTW							
	Incl. BTW							

STOF AFZUIGSET VOOR BOOR- EN BREEKHAMERS

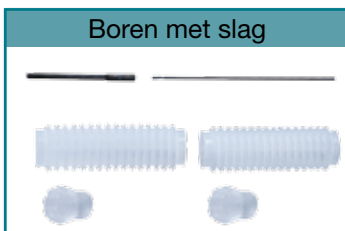

De afzuiging is aangesloten op het handvat van de boor- en breekhamer.

		196535-8	195866-2	196861-5
		HR4013C	HR4511C	HR5212C
Prijs in €	Excl. BTW			
	Incl. BTW			

SOFT NO LOAD

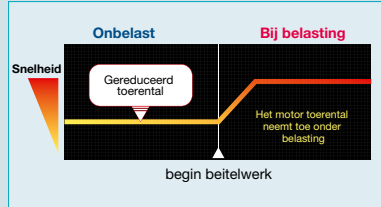

Het toerental van de machine automatisch gereduceerd bij nullast om onwelkome vibraties nog verder te reduceren.

BREEKHAMERS SDS-MAX



SOFT NO LOAD

Reductie toerental bij nullast
HM1213C(V)
HM1214C(V)



HM0871C(V)
HM1111C(V)
HM1213C(V)
HM1214C(V)



	HM0870C	HM0870CV	HM0871C	HM0871CV	HM1101C	HM1101CV
Vermogen	1100 Watt	1100 Watt	1100 Watt	1100 Watt	1300 Watt	1300 Watt
Slagfrequentie	1100-2650 /min.	1100-2650 /min.	1100-2650 /min.	1100-2650 /min.	1100-2600 /min.	1100-2600 /min.
Slagenergie	7,6 J	7,6 J	8,1 J	8,1 J	11,5 J	11,5 J
Triax vibratie beitelen (ah)	11,5 m/s ²	11,5 m/s ²	8 m/s ²	8 m/s ²	13,5 m/s ²	13,5 m/s ²
Gewicht	5,1 kg	5,1 kg	5,8 kg	5,8 kg	7 kg	7 kg
Prijs in €	Excl. BTW					
	Incl. BTW					



CV modellen inclusief stofafzuigset

	HM1111C	HM1111CV	HM1203C	HM1203CV	HM1213C	HM1213CV	HM1214C	HM1214CV
Vermogen	1300 Watt	1300 Watt	1510 Watt	1510 Watt	1510 Watt	1510 Watt	1510 Watt	1510 Watt
Slagfrequentie	1100-2600 /min.	1100-2600 /min.	950-1900 /min.	950-1900 /min.	950-1900 /min.	950-1900 /min.	950-1900 /min.	950-1900 /min.
Slagenergie	11,2 J	11,2 J	19,1 J	19,1 J	18,6 J	18,6 J	19,9 J	19,9 J
Triax vibratie beitelen (ah)	8 m/s ²	8 m/s ²	15,5 m/s ²	15,5 m/s ²	7 m/s ²	7 m/s ²	8 m/s ²	8 m/s ²
Gewicht	7,7 kg	7,7 kg	9,7 kg	9,7 kg	10,8 kg	10,8 kg	12,3 kg	12,3 kg
Prijs in €	Excl. BTW							
	Incl. BTW							

STOF AFZUIGSET VOOR BEITELLEN



Voor:
HM0870C, HM0871C
HM1101C, HM1111C
HM1203C, HM1213C
HM1214C

Prijs in €	Excl. BTW	196572-2
	Incl. BTW	

BIKHAMER / VLOERSCHRAPER SDS-PLUS



HK1820

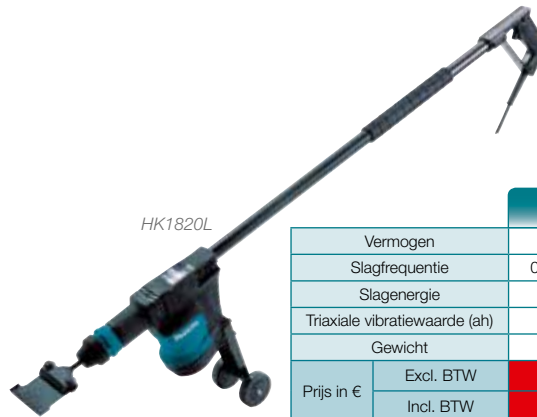

HK1820L

	HK1820	HK1820L
Vermogen	550 Watt	510 Watt
Slagfrequentie	0-3200 /min.	0-3100 /min.
Slagenergie	3,1 J	2,5 J
Triaxiale vibratiewaarde (ah)	10 m/s ²	6,5 m/s ²
Gewicht	3,4 kg	5,3 kg
Prijs in €	Excl. BTW	
	Incl. BTW	

ZELF AANSCHERPENDE BEITELS

			Prijs Excl. BTW	Prijs Incl. BTW
B-30520	Beitelset SDS-MAX, bestaande uit de zelf-aanscherpende beitels: 2 puntbeitels 400mm, 2 koudbeitels 25x400mm en 1 platbeitel 50x400mm.			
B-14009	Zelf-aanscherpende koudbeitel met opname SDS-Max, voor algemeen hak- en breekwerk in muren en beton. Lengte: 400mm Breedte: 27mm			
B-14015	Zelf-aanscherpende platbeitel met opname SDS-Max, voor materiaal-verwijdering in grotere hoeveelheden. Lengte: 350mm Breedte: 50mm			
B-14021	Zelf-aanscherpende tegelbeitel met opname SDS-Max, door zijn licht gebogen vorm ideaal voor het afbikken van wandtegels. Lengte: 300mm Breedte: 50mm			
B-23064	Zelf-aanscherpende puntbeitel met opname SDS-Max, voor algemeen hak- en breekwerk in muren en beton. Dank zij het dynamisch profiel van de beitel, blijft het beitelpunt scherper dan bij een standaard puntbeitel. Het afbraakwerk is productiever en de levensduur van de beitel verhoogd.			

BREEKHAMERS MET ZESKANTOPNAME

PROMO

Trolley ter waarde van € bij HM1812



HM1812

HM1810



HM1400

AVT
ANTI-VIBRATION TECHNOLOGY

SOFT NO LOAD

Reductie toerental bij nullast
HM1317C
HM1812

HM1317C



	HM1317C	HM1400	HM1812
Vermogen	1510 Watt	1240 Watt	2000 Watt
Slagfrequentie	730-1450 /min.	1200 /min.	870 /min.
Slagenergie	25 J	29,5 J	72,8 J
Bitopname hex.	30 mm	30 mm	28,6 mm
Gewicht	17 kg	18,1 kg	31,3 kg
Opvolger van	-	-	HM1810
Prijs in €	Excl. BTW		
	Incl. BTW		

KLOPBOORMACHINES



HP2071FJ



HP1631KSP HP2051FHJ HP2051FHJ
HP2071FJ HP2071FJ

	HP1631KSP	HP2051FHJ	HP2071FJ
Vermogen	710 Watt	720 Watt	1010 Watt
Toerental	0-3200 t.p.m.	0-2900 t.p.m.	0-2900 t.p.m.
Ø Max. staal	13 mm	13 mm	18 mm
Ø Max. hout	30 mm	40 mm	40 mm
Ø Max. steen	16 mm	20 mm	20 mm
Boorkop	1,5-13 mm	1,5-13 mm	1,5-13 mm
Gewicht	2 kg	2,5 kg	2,6 kg
Prijs in €	Excl. BTW		
	Incl. BTW		

BOORMACHINE

450 Watt



		6413
Vermogen		450 Watt
Toerental		0-3400 t.p.m.
Ø Max. staal		8 mm
Ø Max. hout		25 mm
Boorkop		1 - 10 mm
Gewicht		1,3 kg
Prijs in €	Excl. BTW	
	Incl. BTW	

BOORMACHINES (MET 2 SNELHEDEN)



DP2011



DP4011

DP4011
Met 2 snelheden

	DP2011	DP4011	DP4001	DP4003
Vermogen	370 Watt	720 Watt	750 Watt	750 Watt
Toerental	0-4200 t.p.m.	0-2900 t.p.m.	0-950 t.p.m.	0-700 t.p.m.
Ø Max. staal	6,5 mm	13 mm	13 mm	13 mm
Ø Max. hout	15 mm	40 mm	38 mm	38 mm
Boorkop	0,8 - 6,5 mm	1,5 - 13 mm	1,5 - 13 mm	1,5 - 13 mm
Gewicht	1,1 kg	2,3 kg	2,3 kg	2,4 kg
Prijs in €	Excl. BTW			
	Incl. BTW			

HAAKSE (HOOGKOPPEL) BOORMACHINES



DA4000LR



DA3010F



DA3011F



DA3010FJ
DA3011FJ



DA4031

	DA3010FJ	DA3011FJ	DA4000LR	DA4031
Vermogen	450 Watt	450 Watt	710 Watt	1050 Watt
Toerental	0-2400 t.p.m.	0-2400 t.p.m.	900 t.p.m.	1200 t.p.m.
Ø Max. staal	10 mm	10 mm	13 mm	13 mm
Ø Max. hout	25 mm	25 mm	38 mm	118 mm
Boorkop	1 - 10 mm	1 - 10 mm	2 - 13 mm	2 - 13 mm
Gewicht	1,6 kg	1,6 kg	4,0 kg	6,3 kg
Prijs in €	Excl. BTW			
	Incl. BTW			



KERNBOORMACHINE MET MAGNEETVOET



		HB500
Vermogen		1150 Watt
Toerental		650 t.p.m.
Ø Max. staal		50 mm
Klemkracht magneetvoet		9300 N
Inhoud snijvloei-stoftank		350 ml
Gewicht		18,5 kg
Prijs in €	Excl. BTW	
	Incl. BTW	



DIAMANTKERNBOORMACHINE (MET BOORSTANDAARD)



DBM230W

DBM131W / DBM230W
Geleverd met boorstandaard

	DBM131	DBM131W	DBM230W
Vermogen	1700 Watt	1700 Watt	2500 Watt
Toerental onbelast 1	1100 t.p.m.	1100 t.p.m.	390 t.p.m.
Toerental onbelast 2	-	-	1040 t.p.m.
Toerental	2300 t.p.m.	2300 t.p.m.	1700 t.p.m.
Toerental belast max.	1570 t.p.m.	1570 t.p.m.	1250 t.p.m.
Ø Max. beton	132 mm	132 mm	230 mm
Gewicht	6,1 kg	6,1 kg	6,9 kg
Prijs in €	Excl. BTW		
	Incl. BTW		

MENGERS



UT1200



UT1600



	UT1200	UT1400	UT1401	UT1600
Vermogen	960 Watt	1300 Watt	1300 Watt	1800 Watt
Toerental onbelast max.	0-360 t.p.m.	0-900 t.p.m.	0-730 t.p.m.	0-970 t.p.m.
Toerental belast max.	0-360 t.p.m.	0-580 t.p.m.	0-450 t.p.m.	0-580 t.p.m.
Schroefdraad spindel	M14	M14	M14	M14
Gewicht	3,2 kg	5,2 kg	5,5 kg	7,1 kg
Opvolger van	UT2204	-	-	-
Prijs in €	Excl. BTW			
	Incl. BTW			



BOORMACHINE / MENGER

750 Watt



	DS4012	
Vermogen	750 Watt	
Toerental	600 t.p.m.	
Ø Max. staal	13 mm	
Ø Max. hout	36 mm	
Boorkop	2 - 13 mm	
Gewicht	2,8 kg	
Opvolger van	DS4011	
Prijs in €	Excl. BTW	
	Incl. BTW	

BETONBOREN SDS-MAX ULTRAMAX

Hamerboor speciaal ontwikkeld voor de professional. Zes snijvlakken en 3 centreerpunten asymmetrisch verdeeld over de kop, een verstevigde schacht, breder wordende en afgeronde spiraalgroeven maken van deze hamerboor het ideale toebehoren voor al uw boorwerkzaamheden in beton met of zonder wapening.

Best. Nr.	Ø (mm)	Lengte (mm)	Prijs	
			Excl. BTW	Incl. BTW
*B-05260	12	340		
*B-05371	12	540		
*B-05555	12	690		
*B-05212	14	340		
*B-05387	14	540		
B-05228	15	340		
B-05393	15	540		
B-05234	16	340		
B-05402	16	540		
B-05561	16	690		
B-05692	16	920		
B-05240	18	340		
B-05418	18	540		
B-05577	18	690		
B-05701	18	920		
B-05262	20	340		
B-05424	20	540		
B-05583	20	690		
B-05717	20	920		
B-05278	22	340		
B-05430	22	540		
B-05599	22	690		
B-05723	22	920		
B-05284	24	340		
B-05446	24	540		
B-05608	24	690		

Best. Nr.	Ø (mm)	Lengte (mm)	Prijs	
			Excl. BTW	Incl. BTW
B-05739	24	920		
B-05290	25	340		
B-05452	25	540		
B-05614	25	690		
B-05745	25	920		
B-05315	28	340		
B-05474	28	540		
B-05636	28	690		
B-05767	28	920		
B-05321	30	340		
B-05480	30	540		
B-05642	30	690		
B-05773	30	920		
B-05337	32	340		
B-05496	32	540		
B-05658	32	690		
B-05789	32	920		
B-05343	35	340		
B-05505	35	540		
B-05664	35	690		
B-05795	35	920		
B-05359	38	340		
B-05527	38	540		
B-05365	40	340		
B-05533	40	540		
B-05686	40	690		

Best. Nr.	Ø (mm)	Lengte (mm)	Prijs	
			Excl. BTW	Incl. BTW
B-05804	40	920		
B-30405	45	570		
B-30411	45	690		
B-30427	45	920		

Maximale prestaties
Langere levensduur
Uitstekend rendement



* 2 snijder

SNELWISSEL ADAPTER
VOOR GATZAGEN
EZYCHANGE
(B-11536)



€
Excl. BTW €
Incl. BTW

KOFFER 7 BI-METAAL
GATZAGEN «EZYCHANGE»
(B-18188)

(25, 32, 40, 51, 65, 68, 76 mm)



€
Excl. BTW €
Incl. BTW

CENTREERBOOR HSS-G
EZYCHANGE
(B-11542)



€
Excl. BTW €
Incl. BTW

KOFFER 6 BI-METAAL
GATZAGEN (D-24898)

Ø 20, 25, 32, 40, 51, 65 mm



€
Excl. BTW €
Incl. BTW

SCHROEFAUTOMATEN

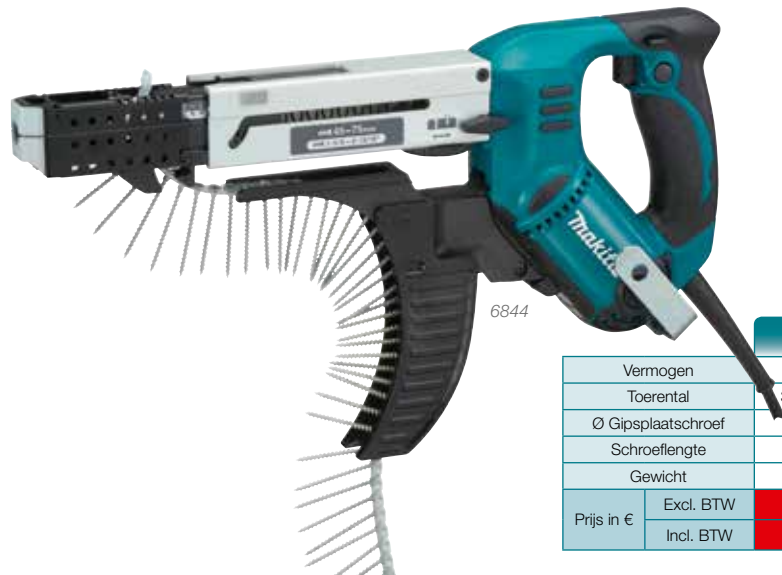

Doos van 2000 schroeven	PH2 geschikt voor gipsplaat op metal-stud		PH2 geschikt voor gipsplaat op hout
Afmetingen (mm)	3,5 x 25	3,5 x 41	3,8 x 41
Best. Nr.	F-32830	F-32856	F-32898
6841R	x	x	x
Prijs en €	Excl. BTW		
	Incl. TVA		

	6844	6843J
Vermogen	470 Watt	470 Watt
Toerental	3000 t.p.m.	6000 t.p.m.
Ø Gipsplaatschroef	4,2 mm	4,2 mm
Schroeflengte	45-75 mm	25-55 mm
Gewicht	2 kg	2 kg
Prijs in €	Excl. BTW	
	Incl. BTW	



Doos van 1000 schroeven	PH2 geschikt voor fermacell op metal stud en hout		PH2 houtschroeven	PROMO 100 schroeven op lint	PH2 geschikt voor gipsplaat op metal-stud	PH2 geschikt voor gipsplaat op hout	
Afmetingen (mm)	3,9 x 30	3,9 x 45	4,2 x 40	4,2 x 55	Afmetingen (mm)	3,9 x 35 mm	3,9 x 41 mm
Best. Nr.	P-04145	P-31382	F-37052	F-31214	Best. Nr.	F-31722	F-31735
6843	x	x	x	x	6843	x	x
6844		x		x	6844	-	-
6844					BFR540 / BFR550	x	x
Prijs (Excl. BTW)					Prijs (Excl. BTW)		
Prijs (Incl. BTW)					Prijs (Incl. BTW)		

SCHROEFMACHINES



Geschikt voor dubbele gevelbekleding en plaatstaal.

FS2701K = koppelinstelling
FS2500K = diepteinstelling

FS2701K

	FS2500K	FS2701K
Vermogen	570 Watt	570 Watt
Toerental	0-2500 t.p.m.	0-2500 t.p.m.
Ø Gipsplaatschroef	5 mm	6 mm
Gewicht	1,6 kg	1,7 kg
Prijs in €	Excl. BTW	
	Incl. BTW	

SCHROEFMACHINES VOOR GIPSPLAAT



FS6300RK

Geschikt voor gipsplaten op metalen profielen



FS4000K

	FS4000K	FS6300RK
Vermogen	570 Watt	570 Watt
Toerental	0-4000 t.p.m.	0-6000 t.p.m.
Ø Gipsplaatschroef	5 mm	5 mm
Gewicht	1,3 kg	1,4 kg
Opvolger	FS4000	-
Prijs in €	Excl. BTW	
	Incl. BTW	



INCLUSIEF : Quick lock kabel 4m

SLAGMOERSLEUTELS



TW0350J

MAK PAC
 TW0200J TW1000
 TW0350J
 6906J

	TW0200J	TW0350J	6906J	TW1000
Vermogen	380 Watt	400 Watt	650 Watt	1300 Watt
Hard koppel	200 Nm	350 Nm	588 Nm	1000 Nm
Bitopname	1/2" vierkant	1/2" vierkant	3/4" vierkant	1" vierkant
Gewicht	2,2 kg	3 kg	5,6 kg	8,6 kg
Opvolger van	TW0200	TW0350	-	-
Prijs in €	Excl. BTW			
	Incl. BTW			

KNABBELSCHAAR

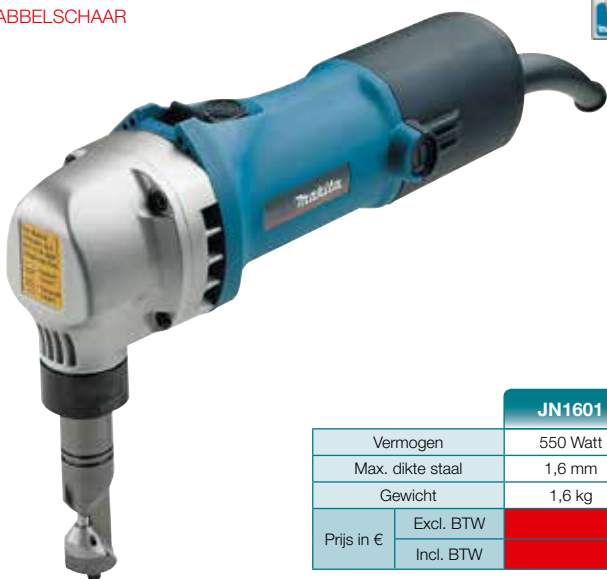

		JN1601
Vermogen		550 Watt
Max. dikte staal		1,6 mm
Gewicht		1,6 kg
Prijs in €	Excl. BTW	
	Incl. BTW	

KNABBELSCHAAR



		JN3201J
Vermogen		710 Watt
Max. dikte staal		3,2 mm
Gewicht		3,4 kg
Prijs in €	Excl. BTW	
	Incl. BTW	

(BOCHTEN) PLAATSCHAREN



JS1602



JS3201J

JS3201J
 JS1601J

	JS1000	JS1601J	JS1602	JS3201J
Vermogen	380 Watt	380 Watt	380 Watt	710 Watt
Aantal zaagbewegingen	4500 /min.	4500 /min.	4000 /min.	1600 /min.
Max. dikte staal	1 mm	1,6 mm	1,6 mm	3,2 mm
Gewicht	1,4 kg	1,4 kg	1,6 kg	3,4 kg
Opvolger van	-	JS1601	-	-
Prijs in €	Excl. BTW			
	Incl. BTW			

HAAKSE SLIJPERS 125 MM

720 Watt



GA5034

Dodemansschakelaar: motor schakelt uit bij loslaten van schakelaar voor verhoogde veiligheid



GA5030RSP2

NIEUW

		GA503RSP2	GA5034
Vermogen		720 Watt	720 Watt
Toerental		11000 t.p.m.	11000 t.p.m.
Ø schijf		125 mm	125 mm
Gewicht		1,8 kg	1,9 kg
Prijs in €	Excl. BTW		
	Incl. BTW		

HAAKSE SLIJPERS 125 MM

840 Watt



9558HNRGK3

125 mm

NIEUW

NIEUW

		9558HNRGZ	9558PBGY	9558HNRGK3
Vermogen		840 Watt	840 Watt	840 Watt
Toerental		11000 t.p.m.	11000 t.p.m.	11000 t.p.m.
Ø schijf		125 mm	125 mm	125 mm
Gewicht		2,1 kg	2,1 kg	2,1 kg
Opvolger van		9558HNGZ	-	9558HNGKD2
Prijs in €	Excl. BTW			
	Incl. BTW			



9558PBGY met dodemansschakelaar: motor schakelt uit bij loslaten van schakelaar voor verhoogde veiligheid

STOFAFZUIGING VOOR 125MM DOORSLIJPERS (196845-3)



€ Excl. BTW
€ Incl. BTW

HAAKSE SLIJPERS 125 MM

1100 Watt / 1400 Watt



GA5040RKDJ

GA5040CJD1

GA5040C
GA5040CJD
GA5041CT01

GA5040CJD
GA5040RKDJ
GA5040CJD

GA5041TX2 / GA5041CT01 MET MECHANISCHE MOTORREM

NIEUW

		GA5040RZ	GA5040RKDJ	GA5041TX2	GA5040C	GA5040CJD	GA5040CJD1	GA5041CT01
Vermogen		1100 Watt	1100 Watt	1100 Watt	1400 Watt	1400 Watt	1400 Watt	1400 Watt
Toerental		11000 t.p.m.	11000 t.p.m.	11000 t.p.m.	2800-11000 t.p.m.	2800-11000 t.p.m.	2800-11000 t.p.m.	2800-11000 t.p.m.
Ø schijf		125 mm	125 mm	125 mm	125 mm	125 mm	125 mm	125 mm
Gewicht		2,4 kg	2,4 kg	2,6 kg	2,4 kg	2,4 kg	2,4 kg	2,7 kg
Opvolger van		GA5040Z	GA5040JD	-	-	GA5040CKD	9565CVRDUST	-
Prijs in €	Excl. BTW							
	Incl. BTW							



Bladveer absorbeert trillingen en schokken tijdens het slijpen.

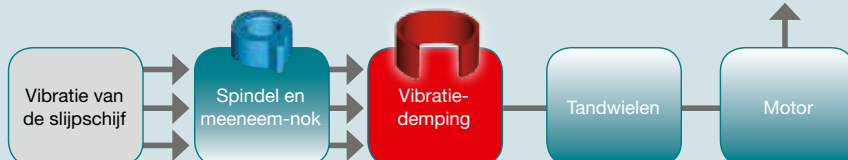
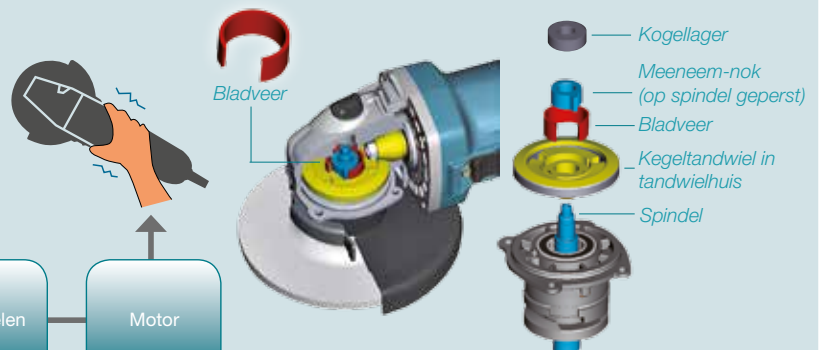

HAAKSE SLIJPERS 125 MM



9566PCV01



Anti-vibratie handgreep & dodemansschakelaar

Dodemansschakelaar:
motor schakelt uit bij loslaten van schakelaar voor verhoogde veiligheid

1400 Watt



9565PCV01

		9565PCV01	9566PCV01
Vermogen		1400 Watt	1400 Watt
Toerental		2800-11500 t.p.m.	4000-10000 t.p.m.
Ø schijf		125 mm	150 mm
Gewicht		2,6 kg	2,7 kg
Prijs in €	Excl. BTW		
	Incl. BTW		

HAAKSE SLIJPERS 125 MM



GA5021CY



GA5021CYX1:
Anti-vibratie handgreep
Ezynut sluitmoer
Doorslijpschijf

GA5021C: MAKPOWER
GA5021CY / CYX1: MAKPOWER & dodemansschakelaar

1450 Watt



		GA5021C	GA5021CY	GA5021CYX1
Vermogen		1450 Watt	1450 Watt	1450 Watt
Toerental		10000 t.p.m.	10000 t.p.m.	10000 t.p.m.
Ø schijf		125 mm	125 mm	125 mm
Gewicht		3 kg	3 kg	3 kg
Prijs in €	Excl. BTW			
	Incl. BTW			

10 x
Doorslijpschijven
in blik



Best. Nr.	Ø (mm)	Dikte (mm)	Ø asgat (mm)	Prijs	
				Excl. BTW	Incl. BTW
D-18764-10	115	1,2	22, 23		
D-18770-10	125	1,2	22, 23		



HAAKSE SLIJPERS 150-180 MM

1400 Watt / 2000 Watt



GA7050

		GA7050	GA6040C
Vermogen		2000 Watt	1400 Watt
Toerental		8500 t.p.m.	4000-9000 t.p.m.
Ø schijf		180 mm	150 mm
Gewicht		4,5 kg	2,5 kg
Prijs in €	Excl. BTW		
	Incl. BTW		

HAAKSE SLIJPERS 230 MM

2000 Watt / 2200 Watt



GA9012C



GA9012C

GA9012C:
Slechts 4,5 kg
Constate elektronica

GA9020RF:
Zachtaanloop
Heropstartbeveiliging

GA9050:
Slechts 4,7 kg
Dodemansschakelaar

		GA9050	GA9020	GA9020RF	GA9012C
Vermogen		2000 Watt	2200 Watt	2200 Watt	2000 Watt
Toerental		6600 t.p.m.	6600 t.p.m.	6600 t.p.m.	6000 t.p.m.
Ø schijf		230 mm	230 mm	230 mm	230 mm
Gewicht		4,7 kg	5,8 kg	5,8 kg	4,5 kg
Prijs in €	Excl. BTW				
	Incl. BTW				

HAAKSE SLIJPERS 230 MM

2400 Watt / 2600 Watt



GA9030SF01 & GA9040SF01:
Dodemansschakelaar



GA9030RF01 & GA9040RF01:
Draaibare achterhandgreep
Anti-vibratie, Soft-Start
Anti-heropstart

	GA9030SF01	GA9030RF01	GA9040SF01	GA9040RF01
Vermogen	2400 Watt	2400 Watt	2600 Watt	2600 Watt
Toerental	6600 t.p.m.	6600 t.p.m.	6600 t.p.m.	6600 t.p.m.
Ø schijf	230 mm	230 mm	230 mm	230 mm
Gewicht	6,3 kg	6,5 kg	6,7 kg	6,9 kg
Prijs in €	Excl. BTW			
	Incl. BTW			

COMBOPACK SLIJPERS



NIEUW

Leverbaar vanaf juni 2016

		DK0047GX1
Haakse slijper 230mm 2200 Watt		GA9060
Haakse slijper 125mm 840 Watt		9558HNRG
Diamantslijpschijf		2x Diamak DS
Synthetische koffer		✓
Opvolger van		DK1163GX
Prijs in €	Excl. BTW	
	Incl. BTW	

COMBOPACK SLIJPERS



		DK0041X1
Haakse slijper 230mm 2200 Watt		GA9020RF
Haakse slijper 125mm 1100 Watt		GA5040RZ
Diamantslijpschijf		2x Diamak DS
Synthetische koffer		✓
Opvolger van		MEU051
Prijs in €	Excl. BTW	
	Incl. BTW	

SLIJPMOLENS



GB801

		GB602W	GB801
Vermogen		250 Watt	550 Watt
Toerental		2850 t.p.m.	2850 t.p.m.
Ø Slijpsteen		150 mm	205 mm
Gewicht		9 kg	19,8 kg
Prijs in €	Excl. BTW		
	Incl. BTW		

AFKORTSLIJPMACHINE 355MM



LW1400X

PROMO

5 x doorslijpschijven bij LW1400X ter waarde van €

NIEUW

		LW1400X	4131
Vermogen		2200 Watt	1100 Watt
Toerental		3800 t.p.m.	3500 t.p.m.
Zaagdiepte (90°)		115 mm	63 mm
Ø schijf		355 mm	185 mm
Gewicht		17,2 kg	5,1 kg
Prijs in €	Excl. BTW		
	Incl. BTW		

AFKORTMACHINE



		LC1230
Vermogen		1750 Watt
Toerental		1300 t.p.m.
Zaagdiepte (90°)		100 mm
Ø Zaagblad		305 mm
Gewicht		19,3 kg
Prijs in €	Excl. BTW	
	Incl. BTW	

LINTZAAGMACHINE 305MM



JM21000330		€ Excl. BTW
Adapterset voor schuurbanden.		€ Incl. BTW
B-42581		€ Excl. BTW
Schuurbanden 20x2240mm Red • Korrel 80		€ Incl. BTW
B-42597		€ Excl. BTW
Schuurbanden 20x2240mm Red • Korrel 120		€ Incl. BTW

PLATENFREES



NIEUW

		CA5000XJ
Vermogen		1300 Watt
Toerental		2200 - 6400 t.p.m.
Ø Zaagblad		118 mm
Gewicht		5,1 kg
Prijs in €	Excl. BTW	
	Incl. BTW	



		LB1200F
Vermogen		900 Watt
Breedte zaaglint		6 - 16 mm
Gewicht		81,2 kg
Prijs in €	Excl. BTW	
	Incl. BTW	

STEMPELSLIJVERS



GD0811C

NIEUW



GS5000

GD0800C / GD0810C
GD0801C / GD0811C

		GS5000
Vermogen		750 Watt
Ø Slijpsteen		125 mm
Toerental		5600 t.p.m.
Maximum Ø spantang		20 mm
Gewicht		5,0 kg
Prijs in €	Excl. BTW	
	Incl. BTW	

NIEUW

		GD0600	GD0601	GD0603	GD0800C	GD0801C	GD0810C	GD0811C
Vermogen		400 Watt	400 Watt	240 Watt	750 Watt	750 Watt	750 Watt	750 Watt
Uitgangsvermogen		250 Watt	250 Watt	150 Watt	480 Watt	480 Watt	480 Watt	480 Watt
Toerental		25000 t.p.m.	25000 t.p.m.	28000 t.p.m.	7000-28000 t.p.m.	7000-28000 t.p.m.	1800-7000 t.p.m.	1800-7000 t.p.m.
Maximum Ø spantang		6,35 mm	6,35 mm	6 mm	8 mm	8 mm	8 mm	8 mm
Gewicht		1,7 kg	1,7 kg	0,97 kg	1,7 kg	1,7 kg	1,7 kg	2,0 kg
Prijs in €	Excl. BTW							
	Incl. BTW							

BETONSCHUURMACHINE
MET GELEIDEZOO

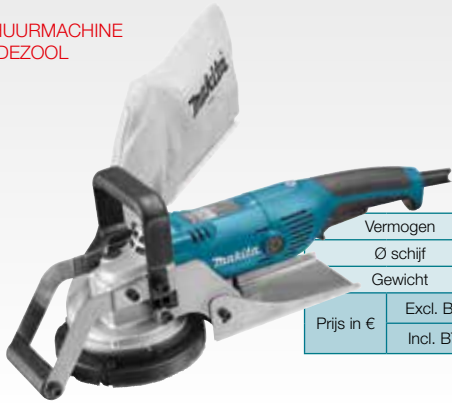

PC5001C	
Vermogen	1400 Watt
Ø schijf	125 mm
Gewicht	5,1 kg
Prijs in €	Excl. BTW
	Incl. BTW

DIAMANTZAAG



4101RH	
Vermogen	860 Watt
Maximale zaagdiepte bij 90°	41 mm
Ø schijf	125 mm
Ø asgat	20 mm
Gewicht	5,2 kg
Prijs in €	Excl. BTW
	Incl. BTW

SLEUVENSLIJPERS



PROMO
2 x diamant slijpschijven
bij SG150 ter waarde
van €

PROMO
2 x diamant slijpschijven
bij SG180 ter waarde
van €



SG180



SG125J

		SG125J	SG150	SG180
Vermogen		1400 Watt	1800 Watt	1800 Watt
Max. slijpdiepte		30 mm	45 mm	60 mm
Sleufbreedte		6 - 30 mm	7 - 35 mm	7 - 43 mm
Ø schijf		125 mm	150 mm	180 mm
Gewicht		4,4 kg	5,7 kg	6 kg
Opvolger van		SG1250	-	-
Prijs in €	Excl. BTW			
	Incl. BTW			

MOTORDOORSLIJPERS

NIEUW

Go Green



EK8100WS



EK6100

3 JAAR GARANTIE
OP MACHINES
Na registratie op
www.makita.be

NIEUW

SLR

SLR

MM4
MAKITA MINI 4-STROKE ENGINE

		EK6100	EK7301W	EK8100WS
Motor		2-taktmotor	2-taktmotor	2-taktmotor
Cilinderinhoud		60,7 cc	72,6 cc	80,7 cc
Vermogen		3,2 kW / 4,3 pk	3,8 kW / 5,2 pk	4,2 kW / 5,7 pk
Maximaal netto koppel		3,9 Nm	4,3 Nm	5,0 Nm
Ø schijf		300 mm	350 mm	400 mm
Decompressieklep		-	✓	✓
Gewicht		8,5 kg	10 kg	10,6 kg
Prijs in €	Excl. BTW			
	Incl. BTW			

EK7651H



DGA504RM

		DK0040M
Motordoorslijper		EK7651H
Haakse slijper		DGA504RM
Accu		1 x BL1840
Prijs in €	Excl. BTW	
	Incl. BTW	

SCHAVERN



Elektronische toerentalregeling

	MAK PAC	MAK PAC	MAK PAC	MAK PAC
	KP0800J	KP0810J	KP0810CJ	KP312S
Vermogen	620 Watt	850 Watt	1050 Watt	2200 Watt
Toerental	17000 t.p.m.	16000 t.p.m.	12000 t.p.m.	12000 t.p.m.
Breedte	82 mm	82 mm	82 mm	312 mm
Max. spaanafname	2,5 mm	4 mm	4 mm	3,5 mm
Gewicht	2,6 kg	3,3 kg	3,4 kg	18,4 kg
Opvolger	-	KP0810K-P	-	-
Prijs in €	Excl. BTW			
	Incl. BTW			

VANDIKTEBANK



	2012NB
Vermogen	1650 Watt
Toerental	8500 t.p.m.
Breedte	304 mm
Max. doorlaathoogte	155 mm
Max. spaanafname	3 mm
Gewicht	28,1 kg
Prijs in €	Excl. BTW
	Incl. BTW

KETTINGFREESMACHINE



	7104L	7104L-30
Vermogen	1140 Watt	1140 Watt
Toerental	3200 t.p.m.	3200 t.p.m.
Kettingsnelheid onbelast	50 m/sec	50 m/sec
Ketting	16 mm	30 mm
Gatbreedte	17-30 mm	30-45 mm
Gatlgte	54-130 mm	54-130 mm
Gewicht	17,3 kg	17,3 kg
Prijs in €	Excl. BTW	
	Incl. BTW	

CIRKELZAGEN

PROMO
 zaagblad 12 tanden bij 5008MGJX ter waarde van €
 zaagblad 24 tanden bij 5143R ter waarde van €

PROMO
 2 x zaagblad 12 tanden bij HS7101JX ter waarde van € &
 2 x zaagblad 16 tanden bij 5903RKX1 ter waarde van €



HS7101JX



HS7601J

MAK PAC
 HS6101J 5705RKX1
 HS7101J 5903RKX1
 HS7601J
 5008MGJX













5008MGJX









	5604R	HS7601J	HS6101J	HS7101JX	5008MGJX	5903RKX1	5103R	5143R
Vermogen	950 Watt	1200 Watt	1100 Watt	1400 Watt	1800 Watt	2000 Watt	2100 Watt	2200 Watt
Zaagdiepte (90°)	54 mm	66 mm	54,5 mm	67 mm	75,5 mm	85 mm	100 mm	130 mm
Ø Zaagblad	165 mm	190 mm	165 mm	190 mm	210 mm	235 mm	270 mm	355 mm
Gewicht	3,9 kg	4,0 kg	3,7 kg	4,0 kg	5,1 kg	7,2 kg	9,4 kg	14,0 kg
Prijs in €	Excl. BTW							
	Incl. BTW							







ZAAGBLADEN

	Best. Nr.	Omschrijving	INFO	Prijs Excl. BTW	Prijs Incl. BTW
	B-42640	T.C.T. zaagblad 250x30x80T voor MDF	2704 LH1040 LH1200F		
	B-42656	T.C.T. zaagblad 300x30x96T voor MDF			
	B-45434	T.C.T. zaagblad 165x20x60T voor MDF	SP6000		
	B-46171	T.C.T. zaagblad 315x30x24T	2712		
	B-46187	T.C.T. zaagblad 315x30x48T	2712		

	Best. Nr.	Omschrijving	INFO	Prijs Excl. BTW	Prijs Incl. BTW
	B-46193	T.C.T. zaagblad 315x30x60T	2712		
	B-49301	T.C.T. zaagblad 165x20 48Tx56T	Twin Pack		
	B-49317	T.C.T. zaagblad 165x20 24Tx40T			
	B-49323	T.C.T. zaagblad 190x30 24Tx40T			
	B-49339	T.C.T. zaagblad 235x30 20Tx40T			

HANDCIRKELZAAGBLADEN

	Best. Nr.	Omschrijving	INFO	Prijs Excl. BTW	Prijs Incl. BTW
	B-08296	HM zaagblad 160x20x24D hout MAKFORCE	5603R 5604R HS6101		
	B-08420	HM zaagblad 160x20x40D hout MAKFORCE			
	B-08006	HM zaagblad 165x20x24D hout M-FORCE			
	B-09329	HM zaagblad 165x20x16D hout met nagels M-FORCE			
	B-13683	HM zaagblad 190x30x12D construction	5704R 5705R HS7101		
	B-08355	HM zaagblad 190x30x24D hout MAKFORCE			
	B-08486	HM zaagblad 190x30x40D hout MAKFORCE			

	Best. Nr.	Omschrijving	INFO	Prijs Excl. BTW	Prijs Incl. BTW
	B-09357	HM zaagblad 190x30x16D hout met nagels SPECIALIZED	5704R 5705R HS7101		
	B-27246	HM zaagblad 210x30x12D construction	5008MG		
	B-13699	HM zaagblad 235x30x16D construction	5903R		
	B-17675	HM zaagblad 235x30x50D SANDWICH panelen			
	B-17681	HM zaagblad 270x30x60D SANDWICH panelen	5103R		
	B-17697	LHM zaagblad 355x30x80D SANDWICH panelen	5143R		

HANDCIRKELZAAGBLADEN MAK SPECIALIZED HOUT MET NAGELS



Best. Nr.	Omschrijving	INFO	Prijs Excl. BTW	Prijs Incl. BTW
B-09329	TCT zaagblad 165x20x16T	5603R 5604R HS6101		
B-09427	TCT zaagblad 165x20x40T			
B-09357	TCT zaagblad 190x30x16T	5704R 5705R HS7101		
B-09503	TCT zaagblad 190x30x40T			
B-09438	TCT zaagblad 210x30x24T	5008MG		
B-09444	TCT zaagblad 235x30x24T	5903R		
B-09519	TCT zaagblad 235x30x48T			
B-09450	TCT zaagblad 270x30x24T	5103R		
B-09531	TCT zaagblad 270x30x60T			
B-09385	TCT zaagblad 355x30x24T	5143R		
B-09547	TCT zaagblad 355x30x60T			

DUIKZAAG 165 MM



PROMO
Geleiderail 1,4 m
ter waarde van €

		SP6000J1
Vermogen		1300 Watt
Zaagdiepte (90°)		57 mm
Zaagdiepte (45°)		40 mm
Maximale zaagdiepte (48°)		38 mm
Ø Zaagblad		165 mm
Gewicht		4,4 kg
Prijs in €	Excl. BTW	
	Incl. BTW	



TELESCOPISCHE DUBBEL-VERSTEKZAGEN

PROMO
Onderstel DEAWST06
bij LS0714FLB /
LS1016FLB / LS1216FLB
ter waarde van €



LS1016FLB
LS1216FLB

LS1016FLB
LS1216FLB
LS0714FLB
LS0815FL

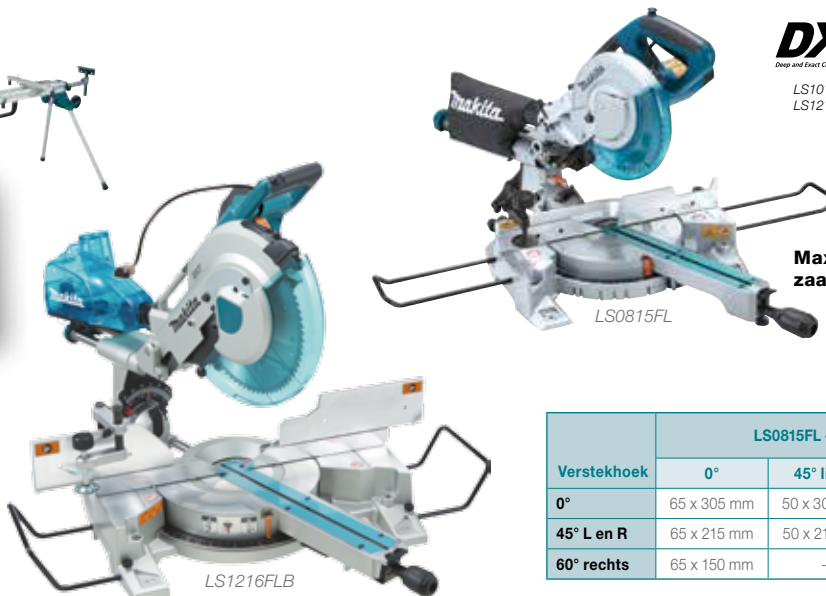

Max. zaaghoogte 65 mm

Model	DEAWST06 - Onderstel
LS0714	✓ 
LS0815	✓ 
LS1016	✓ 
LS1018	✓ 
LS1216	✓ 

Excl. BTW

Verstekhoek	LS0815FL - Snijhoek		
	0°	45° links	5° rechts
0°	65 x 305 mm	50 x 305 mm	60 x 305 mm
45° L en R	65 x 215 mm	50 x 215 mm	-
60° rechts	65 x 150 mm	-	-

Verstekhoek	LS1216FLB - Snijhoek		
	45° links	90°	45° rechts
0°	69x363 mm	102x363 mm	54x363 mm
45° L en R	69x255 mm	102x255 mm	54x255 mm
57° rechts	-	102x220 mm	-
plinten	-	165 mm	-

Verstekhoek	LS0714FLB - Snijhoek		
	45° links	90°	45° rechts
0°	40 x 300 mm	52 x 300 mm	40 x 300 mm
45° L en R	40 x 212 mm	52 x 212 mm	-
57° rechts	-	52 x 163 mm	-

Verstekhoek	LS1018L - Snijhoek		
	45° links	90°	45° rechts
0°	50 x 310 mm	91 x 310 mm	31 x 310 mm
45° L en R	50 x 220 mm	91 x 220 mm	31 x 220 mm
57° rechts	-	91 x 153 mm	-

Verstekhoek	LS1016FLB - Snijhoek		
	45° links	90°	45° rechts
0°	58x279 mm	91x279 mm	43x279 mm
45° L en R	58x197 mm	91x197 mm	43x197 mm
57° rechts	-	91x139 mm	-
plinten	-	120 mm	-

DXT

DEEP CUTTING

De gepatenteerde constructie met drievoudige tandwieloverbrenging en uitsparing achter de flens laat toe om een groter deel van het zaagblad te benutten, waardoor plinten tot 165mm hoogte verticaal kunnen worden afgekort of in verstek gezaagd.



	LS0815FL	LS1018L	LS0714FLB	LS1016FLB	LS1216FLB
Vermogen	1400 Watt	1430 Watt	1010 Watt	1510 Watt	1650 Watt
Ø Zaagblad	216 mm	260 mm	190 mm	260 mm	305 mm
Gewicht	14,2 kg	19,9 kg	13,4 kg	24,3 kg	26,7 kg
Prijs in €	Excl. BTW				
	Incl. BTW				

TAFEL-, AFKORT- EN VERSTEKZAGEN



LF1000



LH1200FL



LH1201FL



Snelle ombouw van tafel- naar afkortzaagfunctie

Verstekhoek	LH1040	LH1200FL	LF1000
	90°	45°	90°
90°	91 x 95 mm 69 x 130 mm	95 x 155 mm 62 x 200 mm	68 x 155 mm 30 x 180 mm
45°	69 x 85 mm	62 x 125 mm	30 x 95 mm

		LH1040F	LH1201FL	LF1000
Vermogen		1650 Watt	1650 Watt	1650 Watt
Ø Zaagblad		260 mm	305 mm	260 mm
Gewicht		14,3 kg	20,7 kg	36 kg
Prijs in €	Excl. BTW			
	Incl. BTW			



MAKBLADE SPECIALIZED HOUT MET NAGELS ZAAGBLADEN

	Best. Nr.	Omschrijving	INFO	Prijs Excl. BTW	Prijs Incl. BTW
	B-40587	T.C.T. zaagblad 190x20x24T	LS0714FLB	€ 35,00	€ 42,35
	B-40593	T.C.T. zaagblad 190x20x40T		€ 45,00	€ 54,54
	B-40602	T.C.T. zaagblad 216x30x24T	LS0815FL	€ 45,00	€ 54,54
	B-40618	T.C.T. zaagblad 216x30x40T		€ 55,00	€ 66,55

Best. Nr.	Omschrijving	INFO	Prijs Excl. BTW	Prijs Incl. BTW
B-40624	T.C.T. zaagblad 260x30x32T	LS1018L LS1016FLB LH1040F LF1000	€ 70,00	€ 84,70
B-40630	T.C.T. zaagblad 260x30x64T		€ 85,00	€ 102,85
B-40646	T.C.T. zaagblad 305x30x32T	LS1216FLB LH1201FL	€ 85,00	€ 102,85
B-40652	T.C.T. zaagblad 305x30x60T		€ 95,00	€ 114,95

TAFELZAAG MET ONDERSTEL



		2704W
Vermogen		1650 Watt
Ø Zaagblad		260 mm
Gewicht		34,9 kg
Prijs in €	Excl. BTW	
	Incl. BTW	

TAFELZAAG



		MLT100
Vermogen		1500 Watt
Ø Zaagblad		260 mm
Gewicht		34,7 kg
Prijs in €	Excl. BTW	
	Incl. BTW	

BOUWCIRKELZAAG MET INDUCTIE MOTOR



		2712
Vermogen		2000 Watt
Ø Zaagblad		315 mm
Gewicht		52,9 kg
Prijs in €	Excl. BTW	
	Incl. BTW	

WIPZAGEN



4351FCTJ





4350FCTJ



JV0600J 4350FCTJ 4351FCTJ
4350FCTJ 4351FCTJ 4329K



		4326	4329K	JV0600J	4350FCTJ	4351FCTJ
Vermogen		450 Watt	450 Watt	650 Watt	720 Watt	720 Watt
Aantal zaagbewegingen		3100 /min.	500-3100 /min.	500-3100 /min.	800-2800 /min.	800-2800 /min.
Maximale capaciteit hout		65 mm	65 mm	90 mm	135 mm	135 mm
Gewicht		1,8 kg	1,9 kg	2,4 kg	2,6 kg	2,5 kg
Prijs in €	Excl. BTW					
	Incl. BTW					

Wipzaagbladen enkelnokschacht LAMINAAT	Best. Nr.	Ø (mm)	Tandafstand (mm)	Type	Prijs	
					Excl. BTW	Incl. BTW
	B-10970	59	1,7	B53		
	B-10986	59	1,4	B54		



RECIPROZAGEN



JR3070CT



JR3070CT

		JR3050T	JR3060T	JR3070CT
Vermogen		1010 Watt	1250 Watt	1510 Watt
Aantal zaagbewegingen		0-2800 /min.	0-2800 /min.	0-2800 /min.
Maximale capaciteit hout		90 mm	255 mm	255 mm
Technologie		Varioschakelaar	Pendelinstelling Varioschakelaar	Avt systeem Regelbaar toerental in 6 posities Pendelinstelling Varioschakelaar
Vibratieniveau		22 m/s ²	23,5 m/s ²	8,5 m/s ²
Gewicht		3,2 kg	4,2 kg	4,4 kg
Prijs in €	Excl. BTW			
	Incl. BTW			

RECIPROZAAGBLADEN VOOR HOUT & METAAL

Best. Nr.	Nuttige lengte (mm)	Tandsteek (tpi)	Hout Metaal	Stuks	Prijs Excl. BTW	Prijs Incl. BTW
B-49834	152x152	6-8	< 100 mm	1		
B-49840	228x152	6-8	< 175 mm	1		
B-49856	305x152	6-8	< 250 mm	1		



BOVENFREZEN



	RP0900J	RP0910J	RP1110CJ	RP1800FX1J	RP2300FCX1J
Vermogen	900 Watt	900 Watt	1100 Watt	1850 Watt	2300 Watt
Toerental	27000 t.p.m.	27000 t.p.m.	8000-24000 t.p.m.	22000 t.p.m.	9000-22000 t.p.m.
Max. induikdiepte	35 mm	57 mm	57 mm	70 mm	70 mm
Spantang	8 mm	8 mm	8 mm	12 mm	12 mm
Gewicht	2,7 kg	2,7 kg	3,4 kg	6 kg	6,1 kg
Prijs in €	Excl. BTW				
	Incl. BTW				

RP2300FCX1J:
Lijnkogellager
Constant-elektronica
Regelbaar toerental
Micrometrische aanslag

KANTENFREZEN



	3709	3710
Vermogen	530 Watt	530 Watt
Toerental	30000 t.p.m.	30000 t.p.m.
Spantang	6 mm	6 mm
Gewicht	1,5 kg	1,6 kg
Prijs in €	Excl. BTW	
	Incl. BTW	



COMBINATIE KANTENFREES / BOVENFREES

4 MACHINES IN 1

- Rechte kantenfrees
- Verstelbare kantenfrees
- Kantenfrees met verschoven spindel
- Bovenfrees

	RT0700CX3J
Vermogen	710 Watt
Toerental	10000-30000 t.p.m.
Max. induikdiepte	35 mm
Spantang	8 mm
Gewicht	1,8 kg
Prijs in €	Excl. BTW
	Incl. BTW

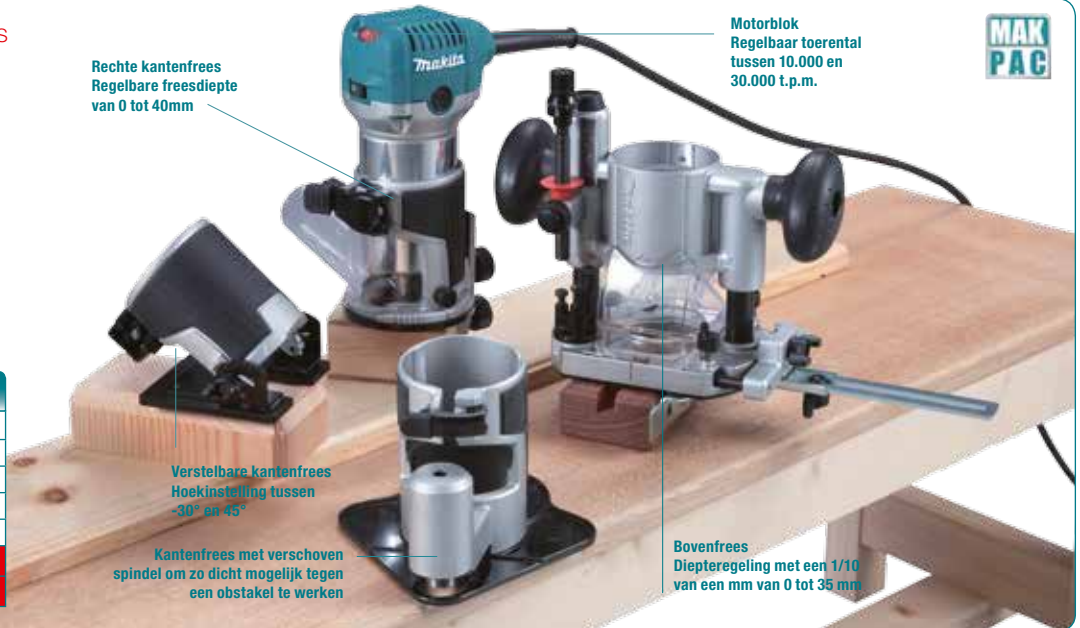

Rechte kantenfrees
Regelbare freesdiepte van 0 tot 40mm

Motorblok
Regelbaar toerental tussen 10.000 en 30.000 t.p.m.

Verstelbare kantenfrees
Hoekinstelling tussen -30° en 45°

Kantenfrees met verschoven spindel om zo dicht mogelijk tegen een obstakel te werken

Bovenfrees
Diepteregeling met een 1/10 van een mm van 0 tot 35 mm

LAMELLENFREES

Revolver diepte-instelling met 6 preselecties voor een snelle afstelling.

Aanslagplaat met tandheugelverstelling voor een snelle en precieze aanpassing aan de materiaaldikte.



Kantelbare voetplaat met handgevergrendelingshendel en automatische stops op 0°, 45° en 90°.

	PJ7000J
Vermogen	700 Watt
Toerental	11000 t.p.m.
Ø zaagblad	100 mm
Asgat	22 mm
Gewicht	2,5 kg
Prijs in €	Excl. BTW
	Incl. BTW

MULTIFUNCTIONEEL OSCILLEREND GEREEDSCHAP



INCLUSIEF:
Set van 9 accessoires en
30 schuurvellen, 1 afzuigset



Gereedschapsloze
accessoirewissel



TM3010CX3J

Vermogen	320 Watt
Toerental	6000-20000/min
Oscillatiehoek	3,2°
Gewicht	1,6 kg
Prijs in €	Excl. BTW
	Incl. BTW

Best. Nr.	Type	Omschrijving	Vorm	Gebruik	Prijs Excl. BTW	Prijs Incl. BTW	
B-21272	TMA001	BIM-TIN segmentzaagblad multimat. Ø 85 mm		Zagen			
B-21288	TMA002	BIM-TIN segmentzaagblad multimat. Ø 65 mm					
B-21294	TMA003	BIM-TIN rondzaagblad multimat. Ø 85 mm					
B-21303	TMA004	BIM-TIN rondzaagblad multimat. Ø 65 mm					
B-21319	TMA005	BIM segmentzaagblad hout en metaal Ø 100 mm					
B-21325	TMA006	BIM segmentzaagblad hout en metaal Ø 85 mm					
B-21331	TMA007	HCS segmentzaagblad voor hout Ø 85 mm					
B-21347	TMA008	BIM invalzaagblad voor hout/nagels 40x65 mm					
B-21353	TMA009	BIM invalzaagblad hout en metaal 28x50 mm					
B-21369	TMA010	BIM invalzaagblad voor hard hout 32x40 mm					
B-21381	TMA012	HCS invalzaagblad voor zacht hout 32x40 mm					
B-21397	TMA013	HCS invalzaagblad voor zacht hout 20x30 mm					
B-21406	TMA014	HCS invalzaagblad voor zacht hout 10x30mm					
B-21412	TMA015	BIM invalzaagblad voor metaal 32x30 mm					
B-21428	TMA016	BIM invalzaagblad voor metaal 20x20 mm					
B-21434	TMA017	BIM invalzaagblad voor metaal 10x20 mm					
B-21440	TMA018	HCS afsteekmes 52x26 mm			Afsteken		
B-21456	TMA019	HCS afsteekmes 52x38 mm					
B-21462	TMA020	BIM segmentzaagblad gekarteld Ø 100 mm		Snijden			
B-21478	TMA021	HCS universele voegsnijder 28x50mm		Snijden			

Best. Nr.	Type	Omschrijving	Vorm	Gebruik	Prijs Excl. BTW	Prijs Incl. BTW
B-21484	TMA022	HM-RIFF specieverwijderaar Ø 70 mm K40		Schaven, voegen, verwijderen		
B-21490	TMA023	HM-RIFF segmentzaagblad Ø 85 mm K30				
B-21509	TMA024	HM-RIFF segmentzaagblad Ø 65 mm K30				
B-21515	TMA025	HM-RIFF schuurplateau Ø 78 mm K30				
B-21521	TMA026	Diamant segmentzaagblad Ø 85 mm K40				
B-34805	TMA027	HM-RIFF invalzaagblad 32x30 mm		Snijden		
B-34811	TMA028	HM-RIFF invalzaagblad 20x20 mm				
B-34827	TMA029	BIM segmentmes, geschikt voor het snijden van linoleum, tapijt en rubber matten.				
B-39213	TMA030	HM invalzaagblad 40x32 mm				
B-39229	TMA031	HM invalzaagblad 30x20 mm				
B-40397	TMA035	HM invalzaagblad 65x40 mm				
B-40406	TMA036	HCS universele voegsnijder 28x50 mm			Snijden	
B-46866	TMA042	Multimes voor diverse materialen		Snijden		





Best. Nr.	Type	Omschrijving	Vorm	Gebruik	Prijs Excl. BTW	Prijs Incl. BTW
B-39235	TMA032	Invalzaagblad 32		Snijden		
B-39241	TMA033	Invalzaagblad 32				
B-39257	TMA034	Invalzaagblad 32				
B-46816	TMA037	Invalzaagblad 32				
B-46822	TMA038	Invalzaagblad 32				
B-46838	TMA039	Segmentmes 32				
B-46844	TMA040	Invalzaagblad 65		Snijden		
B-46850	TMA041	Invalzaagblad 65				
B-46866	TMA042	Multimes voor diverse materialen		Snijden		
B-45478	TMA009	Invalzaagblad 28 - 5 stuks set		Zagen		
B-45484	TMA010	Invalzaagblad 32 - 5 stuks set				
B-45490	TMA012	Invalzaagblad 32 - 5 stuks set				
B-45509	TMA015	Invalzaagblad 32 - 5 stuks set				
B-45515	TMA016	Invalzaagblad 20 - 5 stuks set				
B-45521	TMA032	Invalzaagblad 32 - 5 stuks set				
B-45537	TMA033	Invalzaagblad 32 - 5 stuks set		Snijden		
B-45543	TMA034	Invalzaagblad 32 - 5 stuks set				



Hout (10 stuks)			
Korrel	Best. Nr.	Prijs Excl. BTW	Prijs Incl. BTW
60	B-21624		
80	B-21630		
100	B-22947		
120	B-21646		
150	B-22953		
180	B-21652		
240	B-21668		
Assortiment			
Korrel 60, 80, 100, 240, 320 (2 stuks/K.)	B-21618		

Steen / Glas (10 stuks)			
Korrel	Best. Nr.	Prijs Excl. BTW	Prijs Incl. BTW
120	B-21749		
240	B-21755		
400	B-21761		
600	B-21777		
1200	B-21783		



Verf (10 stuks)		
Assortiment	Prijs Excl. BTW	Prijs Incl. BTW
Korrel 60, 80, 100, 240, 320 (2 stuks/K.)	B-21674	



Hout lange levensduur (10 stuks)		
Assortiment	Prijs Excl. BTW	Prijs Incl. BTW
Korrel 60, 80, 100, 240, 320 (2 stuks/K.)	B-21559	

HANDPALM VLAKSCHUURMACHINES



BO4565K



BO4556K
BO4555K
BO4565K



	BO4556K	BO4555K	BO4558	BO4565K
Vermogen	200 Watt	200 Watt	200 Watt	200 Watt
Aantal schuurbewegingen	14000/min	14000/min	14000 /min.	14000/min
Schuurvoet	112x102 mm	112x102 mm	112x102 mm	112x190 mm
Gewicht	1,1 kg	1,1 kg	1,2 kg	1,2 kg
Prijs in €	Excl. BTW			
	Incl. BTW			

EXCENTRISCHE VLAKSCHUURMACHINES



BO6030JX



BO6030JX
BO6040J



	BO5031K	BO5041K	BO6030JX	BO6040J
Vermogen	300 Watt	300 Watt	310 Watt	750 Watt
Aantal schuurbewegingen	4000-12000/min	4000-12000/min	4000-10000/min	1600-5800/min
Schuurvoet	123 mm	123 mm	147 mm	147 mm
Gewicht	1,3 kg	1,4 kg	2,4 kg	2,8 kg
Opvolger van	-	-	BO6030J	-
Prijs in €	Excl. BTW			
	Incl. BTW			

SCHUUR- EN POETSMACHINES 180 MM 1400W TRAAGDRAAIENDE HAAKSE SLIJPER

1400 Watt



9565CLR



Heropstartbeveiliging

	SA7000C	9565CLR	9237CB
Vermogen	1600 Watt	1400 Watt	1200 Watt
Toerental	0-4000 t.p.m	2000-6800 t.p.m.	0-3200 t.p.m.
Ø schijf	180 mm	125 mm	180 mm
Gewicht	3,4 kg	2,1 kg	3,4 kg
Opvolger van	-	-	9227CB
Prijs in €	Excl. BTW		
	Incl. BTW		

BORSTELSCUURMACHINE



NIEUW

9741J

Vermogen	860 Watt
Toerental	3500 t.p.m.
Gewicht	4,2 kg
Prijs in €	Excl. BTW
	Incl. BTW

HANDPALM VLAKSCHUURMACHINES MET VARIABELE SNELHEID



BO4900VJ

BO4900VJ



Regelbaar toerental

		BO3711	BO4900VJ
Vermogen		190 Watt	330 Watt
Aantal schuurbewegingen		4000-11000/min	4000-10000/min
Schuurvoet		93x185 mm	-
Gewicht		1,6 kg	2,7 kg
Prijs in €	Excl. BTW		
	Incl. BTW		

BANDSCHUURMACHINES



9903J 9403J
9911J 9404J
9920J

9403J:
Zeer krachtig,
ideaal voor intensief
schuurwerk

9403J



9920J



9032



		9911J	9924DB	9903J	9031	9032	9920J	9404J	9403J
Vermogen		650 Watt	850 Watt	1010 Watt	550 Watt	500 Watt	1010 watt	1010 Watt	1200 Watt
Toerental max.		75-270 m/min	400 m/min	210-440 m/min	200-1000 m/min	300-1700 m/min	210-440 m/min	210-440 m/min	500 m/min
Schuurband		75x457 mm	75 x 610 mm	75 x 533 mm	30 x 533 mm	9 x 533 mm	75 x 610 mm	100 x 610 mm	100x610 mm
Gewicht		2,7 kg	4,8 kg	4,3 kg	2,1 kg	1,6 kg	4,5 kg	4,8 kg	5,7 kg
Prijs in €	Excl. BTW								
	Incl. BTW								

Schuurschijf 150mm
velcro multi-gebruik
(15 gaten)



Korrel	Best. Nr.	Stuks	Prijs Excl. BTW	Prijs Incl. BTW
40	B-39300	50		
60	B-39316	50		
80	B-39322	100		
100	B-39338	100		
120	B-39344	100		
240	B-39350	100		
320	B-39366	100		
360	B-39372	100		
400	B-39388	100		
500	B-39394	100		
600	B-39403	100		
800	B-39419	100		
1000	B-39425	100		

Schuurschijf 150mm
Red velcro (15 gaten)
10 stuks



Korrel	Best. Nr.	Prijs Excl. BTW	Prijs Incl. BTW
40	B-51415		
40	B-51459		
60	B-51421		
80	B-51437		
100	B-51443		
180	B-51465		
240	B-51471		
320	B-51487		
400	B-51493		

Schuurschijf 150mm
White velcro (15 gaten)
10 stuks



Korrel	Best. Nr.	Prijs Excl. BTW	Prijs Incl. BTW
40	B-51502		
60	B-51518		
80	B-51524		
100	B-51530		
120	B-51546		
180	B-51552		
240	B-51568		
320	B-51574		
400	B-51580		

STOFZUIGERS

WAT BETEKEN L- OF M-KLASSE?

Stofzuigers voor professioneel gebruik worden volgens EN60335-2-69 ingedeeld in risicoklassen, afhankelijk van het soort stof waarvoor ze geschikt zijn.

L-klasse (Low risk) stofzuigers mogen gebruikt worden voor alle stof waarvan de toelaatbare blootstellingswaarde groter is dan 1 mg/m³. Deze stofzuigers laten minder dan 1% van het opgezogen stof door.

M-klasse (Medium risk) stofzuigers mogen gebruikt worden voor alle stof waarvan de toelaatbare blootstellingswaarde groter is dan 0,1 mg/m³. Deze stofzuigers laten minder dan 0,1% van het opgezogen stof door en voldoen bovendien aan een aantal bijkomende eisen, waaronder permanente debietcontrole en stofarme lediging.

Opgelet: stofzuigers zonder aanduiding van de stofklasse volgens EN60335-2-69 bieden geen enkele garantie op het vlak van persoonlijke veiligheid en zijn derhalve niet geschikt voor professioneel gebruik.

**INCLUSIEF
1 set accessoires**



VC2012L

STOFZUIGERS L-KLASSE

**INCLUSIEF
1 set accessoires**

Klasse L
VC2512L



Klasse L
VC3011L



STOFZUIGERS L-KLASSE & M-KLASSE

**INCLUSIEF
1 set accessoires**

Klasse L
VC2510LX1



Geruisloze zelfreinigende werking van de voorfilter door uitzetting van de schuimfilter bij uitschakelen van de stofzuiger.

Klasse L
VC3210LX1



Geruisloze zelfreinigende werking van de voorfilter door uitzetting van de schuimfilter bij uitschakelen van de stofzuiger.

Klasse M
VC3211MX1



Automatische filterreiniging zonder zuigkrachtonderbreking.

Klasse H
VC3211HX1



Automatische filterreiniging zonder zuigkrachtonderbreking.

STOFZUIGERS L-KLASSE & M-KLASSE

**INCLUSIEF
1 set accessoires**

Klasse L
446LX



Filterreiniging door omgekeerde luchtstroom met een eenvoudige druk op de knop.

Klasse L
447LX



Automatische filterreiniging zonder zuigkrachtonderbreking.

Klasse M
447MX



Automatische filterreiniging zonder zuigkrachtonderbreking.

Klasse M
VC2211MX1



	VC2512L	VC2012L	VC3011L	VC2510LX1	446LX	VC3210LX1	VC2211MX1	VC3211MX1	447LX	VC3211HX1	447MX
Vermogen	1100 Watt	1100 Watt	1000 Watt	1050 Watt	1200 Watt	1050 Watt	1050 Watt	1050 Watt	1200 Watt	1050 Watt	1200 Watt
Max. debiet	3,6 m ³ /min	3,6 m ³ /min	3,6 m ³ /min	3,5 m ³ /min	3,6 m ³ /min	3,5 m ³ /min	3,5 m ³ /min	3,5 m ³ /min	3,6 m ³ /min	3,5 m ³ /min	3,6 m ³ /min
Max. onderdruk	180 mbar	180 mbar	210 mbar	220 mbar	230 mbar	220 mbar	220 mbar	220 mbar	230 mbar	220 mbar	230 mbar
Bruto kuipvolume	23 l	19 l	30 l	32 l	27 l	40 l	22 l	40 l	45 l	40 l	45 l
Gewicht	6,3 kg	7,3 kg	10,5 kg	10,5 kg	10 kg	14,5 kg	16,3 kg	16,9 kg	16 kg	16,9 kg	16 kg
Prijs in €	Excl. BTW										
	Incl. BTW										

BLAAS- EN ZUIGAPPARAAT



Multifunctionele schakelaar

Variable snelheid door de vario-schakelaar



		UB1103
Vermogen		600 Watt
Max. druk		0,057 bar
Max. debiet		0-4,1 m³/min
Gewicht		2,0 kg
Opvolger		UB1101
Prijs in €	Excl. BTW	
	Incl. BTW	

HETELUCHTPISTOLEN (MET REGELBARE TEMPERATUUR)

INCLUSIEF ACCESSOIRES

HG5012K :



HG551VK :



HG651CK :



HG651CK

		HG5012K	HG551VK	HG651CK
Vermogen		1600 Watt	1800 Watt	2000 Watt
Temperatuurbereik		350-500°	100-550°	80-650°
Gewicht		0,6 kg	0,6 kg	0,6 kg
Prijs in €	Excl. BTW			
	Incl. BTW			

COMBOPACK INVALZAAG + WIPZAAG

SP6000J



4351FCTJ

		MEU029J
Duikzaag		SP6000J
Wipzaag		4351FCTJ
Geleidingsrail 1400mm		194368-5
Extra cirkelzaagblad		A-89632
Wipzaagbladjes		5
Prijs in €	Excl. BTW	
	Incl. BTW	



PROMO
Geleiderail & draagtas
ter waarde van €



COMBOPACK KLOPBOORMACHINE + HAAKSE SLIJPER



		DK0050X1
Klopboormachine 710 W		HP1631
Haakse slijper 125mm		GA5030R
Borenset		D-08660
Synthetische koffer		✓
Opvolger van		DK1139
Prijs in €	Excl. BTW	
	Incl. BTW	

GENERATOREN MET AVR-REGELING

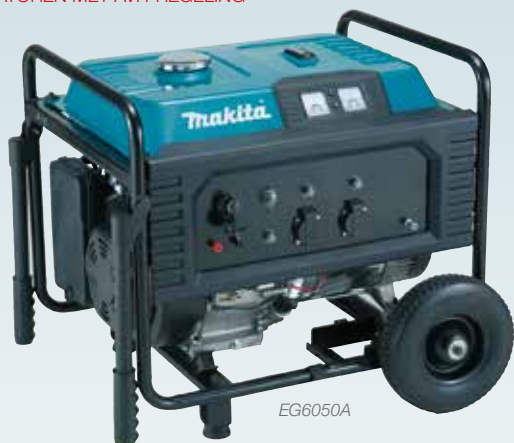

EG6050A



EG2850A



		EG2250A	EG2850A	EG4550A	EG5550A	EG6050A
Motortype		OHV	OHV	OHV	OHV	OHV
Cilinderinhoud		210 cc	210 cc	420 cc	420 cc	420 cc
Spanningsregeling		AVR	AVR	AVR	AVR	AVR
Gewicht		49,8 kg	52,8 kg	95,5 kg	98,5 kg	100,5 kg
Prijs in €	Excl. BTW					
	Incl. BTW					

COMPRESSORS



AC310H



AC1300



PROMO
transportwagen ter waarde
van € bij AC310H

		AC640	AC1300	AC310H
Vermogen		1460 Watt	2100 Watt	1800 Watt
Max. druk		8 bar	10 bar	25,3 bar
Max. debiet		170 l/min	240 l/min	90 l/min
Inhoud persluchtank		6 L	20 L	6,2 L
Gewicht		15 kg	31 kg	36 kg
Prijs in €	Excl. BTW			
	Incl. BTW			

30% LICHTER, 30% COMPACTER - HOGE DRUK = COMPACTE KRACHT

Pneumatische nagel- en nietpistolen zijn niet meer uit de bestelwagen of van de bouwwerf weg te denken. Traditioneel werken ze op een druk van maximaal 8 bar. Makita presenteert nu een Japans technologisch hoogstandje: een compleet systeem van compressoren, persluchtlangen en gereedschappen dat werkt met een druk die bijna drie keer zo hoog is, namelijk 22 bar. Door het gebruik van een dergelijke hoge druk kunnen de machines aanzienlijk kleiner en lichter zijn, zonder in te boeten aan prestaties. Dezelfde kracht kan immers ontwikkeld worden met een kleinere zuiger en minder luchtverplaatsing.



**Hoge druk
luchtslang HP**



B-80008 geleverd met haspel 30 m
350€ Excl. BTW € 423,50 Incl. BTW

Hogedrukslang			
Lengte	7,5 m	15 m	30 m
Best. Nr.	B-80036	B-80014	B-80020
Prijs (Excl. BTW)			
Prijs (Incl. BTW)			

HIGH PRESSURE PINNAGELPISTOLEN



AF500HP



		AF550H	AF500HP
Max. druk		10-23 bar	10-23 bar
Draadkaliber		18 Ga	23 Ga
Doorsnede nagel		1,05-1,25 mm	0,6 mm
Lengte niet		15-55 mm	15-50 mm
Gewicht		1,2 kg	1,1 kg
Prijs in €	Excl. BTW		
	Incl. BTW		

HIGH PRESSURE NAGELPISTOLEN VOOR DAKSHINGLES



AN911H



AN450H

	AN450H	AN510H	AN610H	AN620H	AN711H	AN911H
Max. druk	10-23 bar	10-23 bar	10-23 bar	10-23 bar	13-23 bar	13-23 bar
Ø Nagelkop	9,4 mm	3,4 - 5,0 mm	5,0-7,3 mm	5,5-7,3 mm	5,6-7,5 mm	5,8-7,9 mm
Doorsnede nagel	3,1 mm	1,6 - 2,1 mm	2,1-2,5 mm	2,3-3,3 mm	2,5-3,8 mm	2,5-3,8 mm
Lengte nagel	19-45 mm	27-50 mm	32-65 mm	40-65 mm	45-75 mm	40-90 mm
Gewicht	2,2 kg	1,3 kg	1,9 kg	1,8 kg	2,1 kg	2,3 kg
Prijs in €	Excl. BTW					
	Incl. BTW					

TOEPASSINGSINFORMATIE

Support / Lengte nagel	19 - 45 mm	27 - 50 mm	32 - 65 mm	45 - 65 mm	45 - 75 mm	45 - 90 mm
Dakbedekking	AN450H					
Panelen						
Verpakkingen		AN510H				
Betimmering			AN610H			
Afsluitingen						
Paletten						
Metaal				AN620H		
Tuintimmer						
Daktimmer					AN711H	
Vloerbalken						AN911H
Bekisting						
Gevelbekleding						
Industriebouw						

HIGH PRESSURE
AFWERKINGSNIETPISTOOL



AT450H

Max. druk	13-23 bar	
Draadkaliber	18 Ga	
Doorsnede niet	1,1x1,3 mm	
Lengte niet	25-50 mm	
Gewicht	1,4 kg	
Prijs in €	Excl. BTW	
	Incl. BTW	

HIGH PRESSURE SCHROEFAUTOMAAT



PROMO
20.000 Lint Schroeven
3,5 mm x 25 mm
t.w.v. €

AR410HR

Max. druk	12-23 bar	
Ø Gipsplaatschroef	3,8 mm	
Schroeflengte	25-41 mm	
Gewicht	1,9 kg	
Prijs in €	Excl. BTW	
	Incl. BTW	

PNEUMATISCH
CONSTRUCTIENAGELPISTOOL



AN943K

Max. druk	8,5 bar	
Ø Nagelkop	7,0 mm	
Doorsnede nagel	2,9-3,3 mm	
Lengte nagel	50-90 mm	
Gewicht	3,9 kg	
Prijs in €	Excl. BTW	
	Incl. BTW	



PNEUMATISCH NIETPISTOOL



AT638

Max. druk	8 bar	
Draadkaliber	18 Ga	
Doorsnede niet	1,1x1,3 mm	
Rugbreedte niet	5 mm	
Lengte niet	15-38 mm	
Gewicht	1,5 kg	
Prijs in €	Excl. BTW	
	Incl. BTW	

AFWERKINGSPISTOOL



AF505

Max. druk	8 bar	
Draadkaliber	18 Ga	
Ø Nagelkop	2,0 mm	
Doorsnede nagel	1,2 mm	
Lengte nagel	15-50 mm	
Gewicht	1,4 kg	
Prijs in €	Excl. BTW	
	Incl. BTW	

GASNAGELPISTOOL
VOOR AFWERKNAGELS

7.2V



PROMO
2 x gaspatroon
ter waarde van €



GF600SE

Batterijcapaciteit	7,2 V / 1,0 Ah	
Gemiddelde oplaadtijd	30 min.	
Doorsnede nagel	1,6 mm	
Lengte nagel	15-64 mm	
Gewicht	2,2 kg	
Prijs in €	Excl. BTW	
	Incl. BTW	

GASNAGELPISTOOL VOOR BETON

7.2V



GN420CSE

Batterijcapaciteit	7,2 V / 1,0 Ah	
Gemiddelde oplaadtijd	30 min.	
Doorsnede nagel	2,6-3,0 mm	
Lengte nagel	15-40 mm	
Gewicht	3,5 kg	
Prijs in €	Excl. BTW	
	Incl. BTW	

GASNAGELPISTOOL VOOR HOUT

7.2V 

Gaspatroon duo-pack.



Best. Nr.	194844-9
Prijs (Excl. BTW)	
Prijs (Incl. BTW)	



GN900SE	
Batterijcapaciteit	7,2 V / 1,0 Ah
Gemiddelde oplaadtijd	30 min.
Doorsnede nagel	2,9 - 3,3 mm
Lengte nagel	50-90 mm
Gewicht	3,3 kg
Prijs in €	Excl. BTW
	Incl. BTW

LASER-AFSTANDSMETER



LD030P



LD080PI



	LD030P	LD050P	LD080PI
Bereik	30 m	50m	80m
Gewicht	0,1 kg	0,1 kg	0,1 kg
Prijs in €	Excl. BTW		
	Incl. BTW		

KRUISLIJN LASERS

PROMO
statief 1,5 m
ter waarde van €



SK102Z

SK103PZ



INCLUSIEF
eenvoudige
wandhouder,
magnetische richteenheid

**SK103PZ: laserhoek tot 180°
Pulse/power functie :
Versterkte lichtintensiteit
verhoogde zichtbaarheid in daglicht.**

		SK102Z	SK103PZ
Bereik		15 m	15 m
Gewicht		0,5 kg	0,37 kg
Prijs in €	Excl. BTW		
	Incl. BTW		

ROTERENDE LASER

PROMO
statief 2,7 m
ter waarde van €



INCLUSIEF
statief,
magnetische richtplaat
bril voor laser,
afstandsbediening

		SKR200Z
Rotatiesnelheid		0-600 t.p.m.
Bereik		100 m
Gewicht		1,6 kg
Prijs in €	Excl. BTW	
	Incl. BTW	

ELEKTRISCHE KETTINGZAGEN

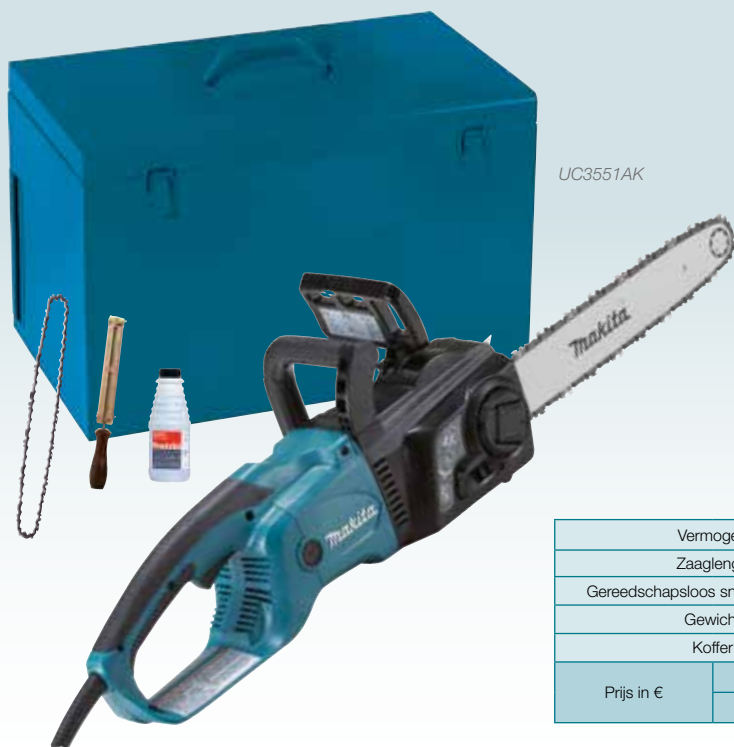

UC3551AK



	UC3541AK	UC3551AK	UC4051AK
Vermogen	1800 Watt	2000 Watt	
Zaaglengte	35 cm		40 cm
Gereedschapsloos snelspansysteem			✓
Gewicht	4,7 kg	5,5 kg	5,6 kg
Koffer			✓
Prijs in €	Excl. BTW		
	Incl. BTW		

ACCU SNOEIKETTINGZAAG

18V
LITHIUM-ION

NIEUW



DUC122RTE



	DUC122RTE	DUC122ZK
Li-ion 18V	2x accu 5,0 Ah	-
Zaagblad	115 mm	
Oplaadtijd	45 min	
Gewicht	2,6 kg	
Prijs in €	Excl. BTW	
	Incl. BTW	

18v + 18v → 36v

Door het gebruik van twee 18V batterijen in serie worden voorheen ongeziene prestaties mogelijk met het meest gebruikte batterijtype; een investering in een apart batterijsysteem voor de zwaarste toepassingen wordt daarmee overbodig.

ACCU SNOEIKETTINGZAAG

NIEUW

18v + 18v → 36v

Go Green



DUC252PM2J

NIEUW

	DUC252PM2J	DUC252Z
Li-ion 18V	2x accu 4,0 Ah	-
Zaaglengte	25 cm	
Snelspansysteem	✓	
Oplaadtijd	2 x 36 min	
Gewicht	4,6 kg	
Prijs in €	Excl. BTW	
	Incl. BTW	



Brandstofverbruik

40% beter

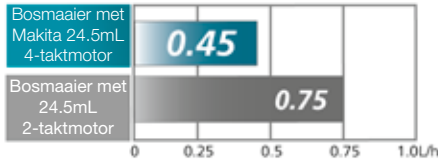

Totale kosten

60% beter

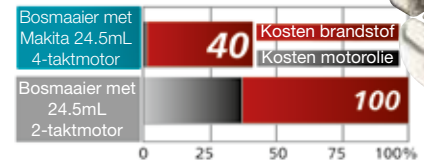

De precieze kosten zijn afhankelijk van de omstandigheden.



BENZINE BOSMAAIERS

Go Green

Anti-vibratie



NIEUW

NIEUW

NIEUW



	EM2651UHX1	EBH341UX2	EM4351UH
4-takt		✓	
Cilinderinhoud	25,4 cc	33,5 cc	43 cc
Vermogen	1,05 pk / 0,77 kW	1,45 pk / 1,07 kW	2,0 pk / 1,5 kW
Handgreepvorm	U		
Gewicht	5,6 kg	7,1 kg	8,6 kg
Prijs in €	Excl. BTW		
	Incl. BTW		

RUGGEDRAGEN BOSMAAIERS

Go Green



	EBH341R	EM4350RH
4-takt	✓	✓
Cilinderinhoud	33,5 cc	43 cc
Vermogen	1,45 pk / 1,07 kW	2,0 pk / 1,5 kW
Handgreepvorm	D	
Gewicht	10,2 kg	12 kg
Prijs in €	Excl. BTW	
	Incl. BTW	

BENZINE BOSMAAIERS



		EM2600U	EM2600L
2-takt		✓	
Cilinderinhoud		25,7 cc	
Vermogen		1,6 pk / 0,83 kW	
Handgreepvorm		U	L
Gewicht		5,0 kg	
Prijs in €	Excl. BTW		
	Incl. BTW		

GRASTRIMMER



		ER2600L
2-takt		✓
Cilinderinhoud		25,7 cc
Vermogen		1,1 pk / 0,8 kW
Handgreepvorm		D
Gewicht		4,5 kg
Prijs in €	Excl. BTW	
	Incl. BTW	

ACCU GRASTRIMMER



		DUR181RFE	DUR181Z
Li-ion 18V		2x accu 3,0 Ah	-
Handgreepvorm		D	
Oplaadtijd		22 min	
Gewicht		2,9 kg	
Prijs in €	Excl. BTW		
	Incl. BTW		

ACCU GRASTRIMMERS

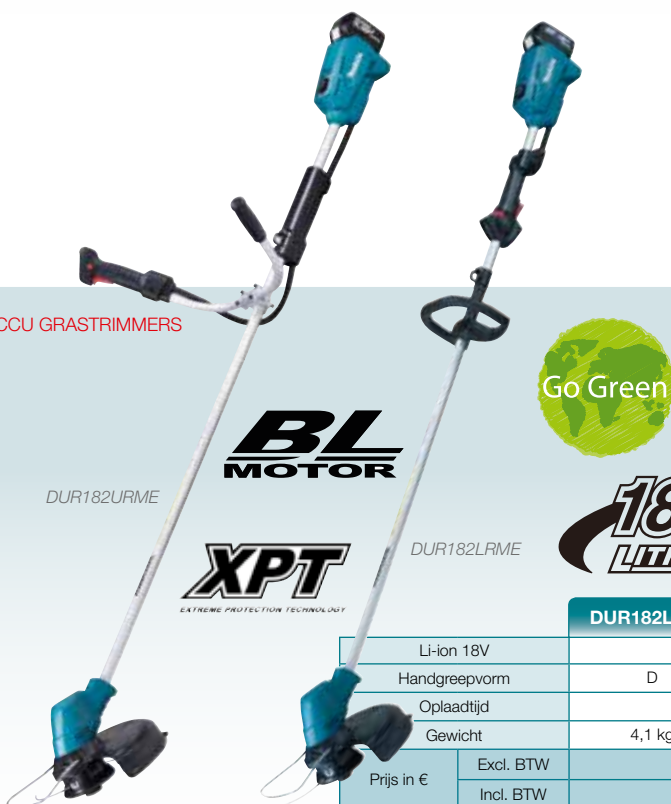

		DUR182LRME	DUR182URME	DUR182LRF	DUR182LZ	DUR182UZ
Li-ion 18V		2x accu 4,0 Ah		1x accu 3,0 Ah	-	-
Handgreepvorm		D	U	D		U
Oplaadtijd		36 min		22 min		
Gewicht		4,1 kg	4,2 kg	4,1 kg		4,2 kg
Prijs in €	Excl. BTW					
	Incl. BTW					



ACCU BOSMAAIER

BL
MOTOR

Go Green

DUR364LPM2

18v + 18v → 36v

		DUR364LPM2	DUR364LZ
Li-ion 18V		2x accu 4,0 Ah	-
Handgreepvorm		D	
Oplaadtijd		2 x 36 min	
Gewicht		4,5 kg	
Prijs in €	Excl. BTW		
	Incl. BTW		

ACCU BOSMAAIER

BL
MOTOR

Go Green

DUR365UPM2

18v + 18v → 36v



		DUR365UPM2	DUR365UZ
Li-ion 18V		2x accu 4,0 Ah	-
Handgreepvorm		U	
Oplaadtijd		2 x 36 min	
Gewicht		5,2 kg	
Prijs in €	Excl. BTW		
	Incl. BTW		

ELEKTRISCHE GRASTRIMMER

		UR3000
Vermogen		450 Watt
Handgreepvorm		D
Gewicht		2,6 kg
Prijs in €	Excl. BTW	
	Incl. BTW	



ELEKTRISCHE GRASTRIMMERS

		UR3500	UR3501
Vermogen		700 Watt	1000 Watt
Handgreepvorm		D	
Gewicht		4,0 kg	4,1 kg
Prijs in €	Excl. BTW		
	Incl. BTW		



MOTOR COMBI-SYSTEEM

MM4
MAKITA MINI 4-STROKE ENGINE



Go Green

EX2650LH	
4-takt	✓
Cilinderinhoud	25,4 cc
Vermogen	1,05 pk / 0,77 kW
Handgreepvorm	D
Gewicht	4,6 kg
Prijs in €	Excl. BTW
	Incl. BTW

MOTOR COMBI-SYSTEEM MET BOSMAAIER OPZETSTUK

Go Green



EM400MP
Ø 42 cm

EX2650LHM1	
4-takt	✓
Cilinderinhoud	25,4 cc
Vermogen	1,05 pk / 0,77 kW
Handgreepvorm	D
Gewicht	6,2 kg
Prijs in €	Excl. BTW
	Incl. BTW



OPZETSTUKKEN VOOR EX2650LH & BUX361

EM400MP EM401MP	ER400MP	EY401MP	EN401MP	KR400MP	EE400MP	LE400MP
<p>Bosmaaier opzetstuk voor EX2650LH (EM400MP) BUX361 (EM401MP)</p> 	<p>Grastrimmer opzetstuk voor EX2650LH</p> 	<p>Snoeiketzingzaag opzetstuk voor EX2650LH / BUX361</p> 	<p>Stokheggenschaar opzetstuk voor EX2650LH / BUX361</p> 	<p>Cultivator opzetstuk voor EX2650LH / BUX361</p> 	<p>Boordensnijder opzetstuk voor EX2650LH / BUX361</p> 	<p>Verlengstuk opzetstuk voor EX2650LH / BUX361</p> 
 <p>EM400MP € excl. BTW € incl. BTW</p>  <p>EM401MP € excl. BTW € incl. BTW</p>	 <p>€ excl. BTW € incl. BTW</p>	 <p>€ excl. BTW € incl. BTW</p>	 <p>€ excl. BTW € incl. BTW</p>	 <p>€ excl. BTW € incl. BTW</p>	 <p>€ excl. BTW € incl. BTW</p>	 <p>€ excl. BTW € incl. BTW</p>

ELEKTRISCHE HEGGENSCHAREN HOBBY

		UH4261	UH4861	UH5261
Vermogen		400 Watt		
Snijlengte		42 cm	48 cm	52 cm
Gewicht		2,9 kg	3,0 kg	
Prijs in €	Excl. BTW			
	Incl. BTW			

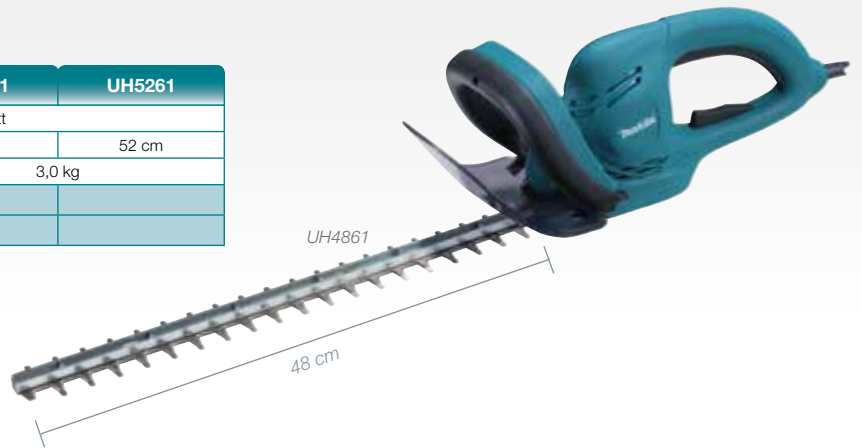

ELEKTRISCHE HEGGENSCHAREN SEMI-PRO

		UH4570	UH5570	UH6570
Vermogen		550 Watt		
Snijlengte		45 cm	55 cm	65 cm
Gewicht		3,6 kg	3,7 kg	3,8 kg
Prijs in €	Excl. BTW			
	Incl. BTW			

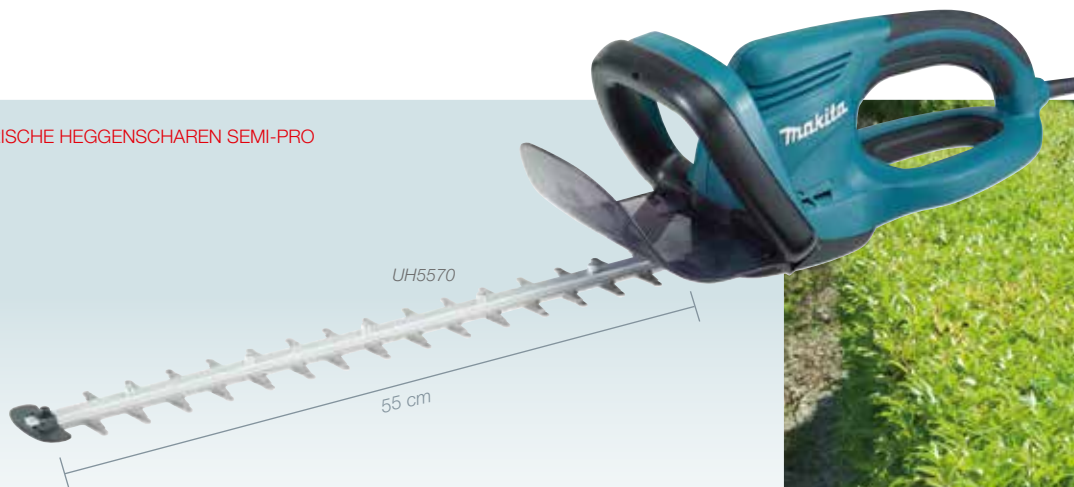

ELEKTRISCHE HEGGENSCHAREN PRO

		UH5580	UH6580	UH7580
Vermogen		670 Watt		
Snijlengte		55 cm	65 cm	75 cm
Gewicht		4,3 kg	4,4 kg	4,6 kg
Prijs in €	Excl. BTW			
	Incl. BTW			

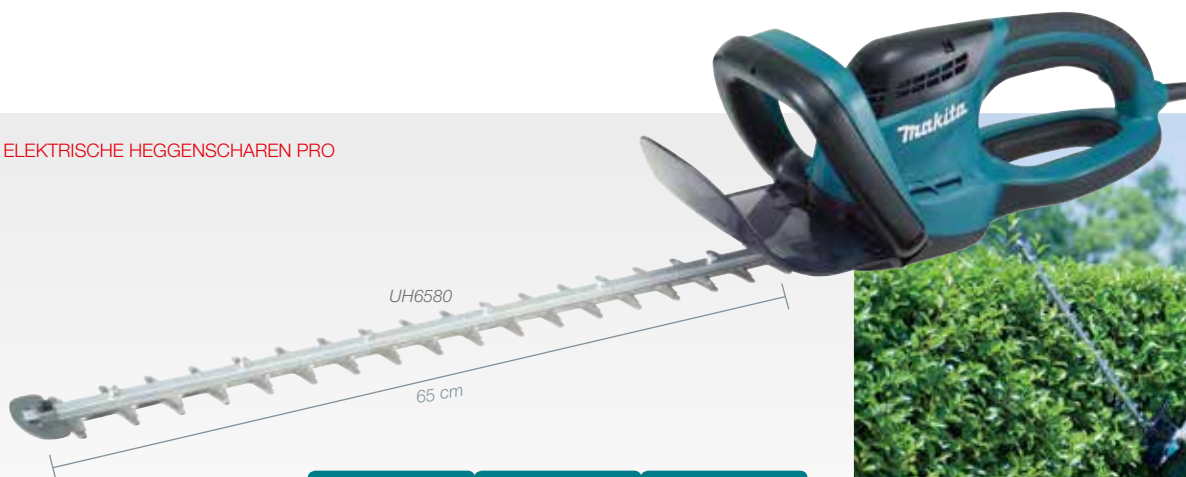

ACCU HEGGENSCHAREN



18V
LITHIUM-ION

		DUH483RFE	DUH483Z	DUH523RFE	DUH523Z
Li-ion 18V		2x accu 3,0 Ah	-	2x accu 3,0 Ah	-
Snijlengte		48 cm		52 cm	
Oplaadtijd		22 min			
Gewicht		3,1 kg		3,2 kg	
Prijs in €	Excl. BTW				
	Incl. BTW				

ACCU HEGGENSCHAREN



18v + 18v → 36v



		DUH551PM2J	DUH551Z	DUH651PM2J	DUH651Z
Li-ion 18V		2x accu 4,0 Ah	-	2x accu 4,0 Ah	-
Snijlengte		55 cm		65 cm	
Oplaadtijd		2 x 36 min			
Gewicht		5,1 kg		5,2 kg	
Prijs in €	Excl. BTW				
	Incl. BTW				



BENZINE HEGGENSCHAAR

		HTR4901
2-taktmotor		✓
Cilinderinhoud		21 cc
Vermogen		0,83 pk / 0,62 kW
Snijlengte		49 cm
Gewicht		4,7 kg
Prijs in €	Excl. BTW	
	Incl. BTW	

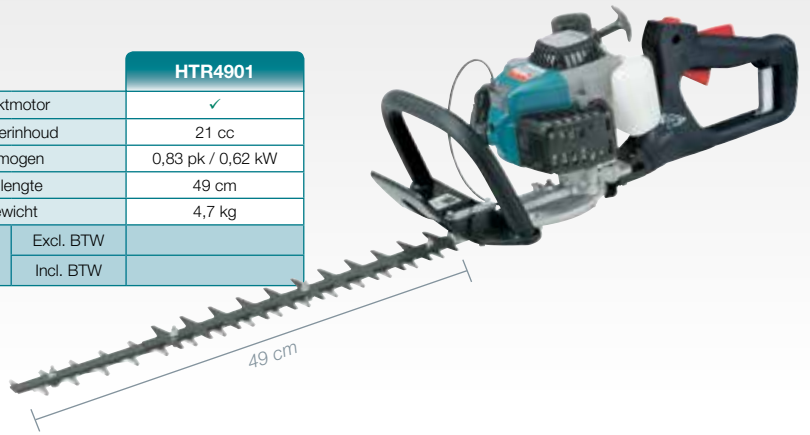

BENZINE HEGGENSCHAREN

		EH5000W	EH6000W	EH7500W	EH7500SX
2-taktmotor			✓		
Cilinderinhoud		22,2 cc			
Vermogen		1,0 pk / 0,7 kW			
Snijlengte		48 cm	59 cm	73 cm	75 cm
Gewicht		4,8 kg	5,0 kg	5,2 kg	4,7 kg
Prijs in €	Excl. BTW				
	Incl. BTW				



Betrouwbare en milieuvriendelijke Makita 4-takt motoren

De 4-takt motoren van Makita bieden volgende voordelen: **Uitstekende prestaties, compact en licht in gewicht, een lage uitstoot, lage gebruikskosten, eenvoudig in onderhoud en ze zijn stil**, zeker in vergelijking met een 2-takt motor van hetzelfde formaat.

Makita 4-takt motoren hebben hoge koppel- en pk-waarden. De maximale koppel- en pk-waarden van een Makita 4-takt motor zijn vrijwel gelijk aan die van een gelijkwaardige 2-takt motor.



BENZINE STOKHEGGENSCHAREN

		EN4950H	EN4951SH
4-taktmotor			✓
Cilinderinhoud		25,4 cc	
Vermogen		1,1 pk / 0,77 kW	
Snijlengte		49 cm	
Totale lengte		255 cm	205 cm
Gewicht		7,2 kg	6,6 kg
Prijs in €	Excl. BTW		
	Incl. BTW		





ELEKTRISCHE GRASMAAIERS

	ELM3311	ELM3711
Vermogen	1100 Watt	1300 Watt
Maaibreedte	33 cm	37 cm
Max. terreinoppervlakte	400 m ²	500 m ²
Maaihogte	20 - 55 mm	
Polypropyleen chassis	✓	
Gewicht	11,5 kg	14,9 kg
Prijs in €	Excl. BTW	
	Incl. BTW	

ELM3711



ELM4613

Incl. mogelijkheid tot mulchen.
Mulching plug inbegrepen.

ELEKTRISCHE GRASMAAIERS

	ELM4612	ELM4613
Vermogen	1800 Watt	
Maaibreedte	46 cm	
Max. terreinoppervlakte	800 m ²	1000 m ²
Maaihogte	20 - 75 mm	
Stalen chassis	✓	
Zelfrijdend	-	✓
Gewicht	28,5 kg	31,5 kg
Prijs in €	Excl. BTW	
	Incl. BTW	



ACCU GRASMAAIERS



DLM431PT2



18v + 18v → 36v

	DLM380PM2	DLM380Z	DLM431PT2	DLM431Z
Li-ion 18V	2x accu 4,0 Ah	-	2x accu 5,0 Ah	-
Maaibreedte	38 cm		43 cm	
Max. terreinoppervlakte	300 m ²		500-1000 m ²	
Maaihogte	25 - 75 mm		20 - 75 mm	
Polypropyleen chassis			✓	
Oplaadtijd	2 x 36 min		2 x 45 min	
Gewicht	15 kg		18 kg	
Prijs in €	Excl. BTW			
	Incl. BTW			

ACCU GRASMAAIER

36V
LITHIUM-ION



BLM430RDE

	BLM430RDE	BLM430Z
Li-ion 36V	2x accu 2,6 Ah	-
Maaibreedte	43 cm	
Max. terreinoppervlakte	300 m ²	
Maaihogte	20 - 75 mm	
Polypropyleen chassis	✓	
Oplaadtijd	22 min	
Gewicht	17,9 kg	
Prijs in €	Excl. BTW	
	Incl. BTW	

BENZINE GRASMAAIERS



PLM4620N

Incl. mogelijkheid tot mulchen.
Mulching plug inbegrepen.



	PLM4120N	PLM4620N
Motortype	Briggs & Stratton 500 E	Briggs & Stratton 625E
Maaibreedte	41 cm	46 cm
Max. terreinoppervlakte	1000 m ²	1200 m ²
Maaihogte	20 - 75 mm	30 - 80 mm
Stalen chassis	✓	
Gewicht	27,5 kg	24 kg
Prijs in €	Excl. BTW	
	Incl. BTW	

BENZINE GRASMAAIERS



PLM5600N

Incl. mogelijkheid tot mulchen.
Mulching plug inbegrepen.



NO PRIME. NO CHOKE.
READY START

	PLM4621N	PLM5113N	PLM5600N
Motortype	Briggs & Stratton 650 E ReadyStart	Briggs & Stratton 675 EX ReadyStart	
Maaibreedte	46 cm	51 cm	56 cm
Max. terreinoppervlakte	1400 m ²	2000 m ²	2200 m ²
Maaihogte	20 - 75 mm		
Stalen chassis	✓		
Zelfrijdend	✓		
Gewicht	33,8 kg	37,7 kg	39,8 kg
Prijs in €	Excl. BTW		
	Incl. BTW		

ELEKTRISCHE VERTICUTEERDERS

		UV3200	UV3600
Vermogen		1300 Watt	1800 Watt
Breedte		32 cm	36 cm
Polypropyleen chassis			✓
Gewicht		15 kg	18,3 kg
Prijs in €	Excl. BTW		
	Incl. BTW		



UV3200



UV3600

HOGEDRUKREINIGERS



HW111



HW132



HW131



HW151



Warmwater
hogedrukreiniger



HW120

		HW111	HW132	HW131	HW151	HW120
Vermogen		1700 Watt	2100 Watt	2200 Watt	2500 Watt	2200 Watt
Druk		110 bar	140 bar	130 bar	150 bar	120 bar
Debiet		370 l/u	420 l/u	500 l/u		510 l/u
Haspel		5,5 m	8 m	15 m	10 m	5 m
Gewicht		7,4 kg	18,8 kg	33 kg	26,9 kg	79 kg
Prijs in €	Excl. BTW					
	Incl. BTW					

STANDAARD TOEBEHOREN		HW111	HW131	HW132	HW151	HW120
Verlengstuk voor spuithandgreep		✓ 3320130				
Spuitmond voor reinigungs mousse		✓ 3640670		✓ 3640670		
Lans met regelbare spuitmond		✓ 3640650	✓ P-64901	✓ 3640930	✓ 40551	✓ 3718
Lans met turbo spuitmond (rotopower)		✓ 3320120	✓ P-64917	✓ 3640940	✓ 40167	
Rechte borstel		✓ 3640950		✓ 3640950		
Koppelstuk			✓ P-64870			
Spuithandgreep		✓ 3320152	✓ P-72431	✓ 3640920	✓ 41154	✓ 40883



SEMI - VUILWATERPOMPEN



EW3051H



		EW2051H	EW3051H
4-takt		✓	
Cilinderinhoud		169 cc	
Inhoud brandstoftank		3,2 l	
Debiet		700 l/min.	1000 l/min.
Gewicht		24,9 kg	26,1 kg
Prijs in €	Excl. BTW		
	Incl. BTW		

WATERPOMPEN



EW3050H



		EW2050H	EW3050H
4-takt		✓	
Cilinderinhoud		169 cc	
Inhoud brandstoftank		3,2 l	
Debiet		520 l/min.	1000 l/min.
Gewicht		24,9 kg	26,1 kg
Prijs in €	Excl. BTW		
	Incl. BTW		

DOMPELPOMPEN



PF0800

PF1010

PF1100

PF1110

		PF0800	PF1010	PF1100	PF1110
Vermogen		800 Watt		1100 Watt	
Max. toevoercapaciteit		140 l/min.	240 l/min.	250 l/min.	
Max. opvoerhoogte		9 m	10 m	9 m	10 m
Gewicht		6,1 kg	6,6 kg	6,7 kg	7,0 kg
Prijs in €	Excl. BTW				
	Incl. BTW				

ACCU GRAS-EN HEGGENSCHAAR



Go Green



		DUM168RFEX	DUM168ZX
Li-ion 18V		2x accu 3,0 Ah	-
Snijbreedte		16 cm	
Oplaadtijd		22 min	
Gewicht		1,6 kg	
Prijs in €	Excl. BTW		
	Incl. BTW		

18V
LITHIUM-ION

ACCU SNOEISCHAAR



		DUP361PM2	DUP361Z
Li-ion 18V		2x accu 4,0 Ah	-
Max. snijcapaciteit		33 mm	
Max. mesopening		54 mm	
Oplaadtijd		2 x 36 min	
Gewicht		3,8 kg / 0,8 kg	
Prijs in €	Excl. BTW		
	Incl. BTW		

ACCU COMBOPACK TUIN

18V
LITHIUM-ION



DHP453



DUR181



DLX2114X1	
Li-ion 18V	2x accu 3,0 Ah
Oplaaftijd	22 min
Accu klopboor- en schroefmachine	DHP453Z
Accu grastrimmer	DUR181Z
Veiligheidsbril	769014-5
Snellader	DC18RC
Prijs in €	Excl. BTW
	Incl. BTW



ACCU COMBOPACK TUIN



DHP453



DUH523

DLX2113X1	
Li-ion 18V	2x accu 3,0 Ah
Oplaaftijd	22 min
Accu heggenschaar	DUH523Z
Accu klopboor- en schroefmachine	DHP453Z
Snellader	DC18RC
Prijs in €	Excl. BTW
	Incl. BTW

18V
LITHIUM-ION

ACCU COMBOPACK TUIN



DUR181

DUM168

DUH523

DLX3018AX	
Li-ion 18V	2x accu 2,0 Ah
Oplaaftijd	24 min
Accu heggenschaar	DUH523Z
Accu grasschaar	DUM168ZX
Accu grastrimmer	DUR181Z
Snellader	DC18RC
Prijs in €	Excl. BTW
	Incl. BTW



18V LITHIUM-ION



DUC122



DUP361



BVF154



DLM431



DUC252



DUB362



DUM168



DUH523



DUR364L



DUH651



DUR181



DUR182U



Makita®

PROFESSIONALS AT WORK

n.v. Makita s.a.
Jan-Baptist Vinkstraat 2 • B-3070 Kortenberg
Tel. (02) 257 18 40 • Fax (02) 253 01 01
e-mail: csd@makita.be • www.makita.be

Afbeeldingen kunnen afwijken van het origineel. Technische gegevens en prijzen zijn indicatief en onder voorbehoud van drukfouten.
Aanbevolen prijzen excl. bebat en recupel. Registratienummer/milieubelasting: 400/000042/81. Promoties geldig tot einde voorraad. Geldig van 01/04/2016 tot 30/09/2016.



REF: PLFNL16